

INSTRUMENTAL INSEMINATION OF QUEEN BEES

OTTO MACKENSEN AND KENNETH W. TUCKER
ENTOMOLOGY RESEARCH DIVISION

Agriculture Handbook No. 390

Washington, D.C.

December 1970

For sale by the Superintendent of Documents, U.S. Government Printing Office
Washington D.C. 20402 — Price 25 cents

CONTENTS

	Page
About the handbook.....	1
Control of mating.....	1
Development of instrumental insemination.....	1
Structure and function of the reproductive organs.....	2
Female reproductive organs.....	2
Male reproductive organs.....	3
Natural mating.....	6
Equipment for instrumental insemination.....	7
Microscope and light.....	7
Carbon dioxide equipment.....	7
Queen holder.....	7
Syringe.....	8
Sting hook and ventral hook.....	9
Valvefold probe and sting depressor.....	12
Manipulating apparatus.....	12
Use of carbon dioxide.....	12
Insemination procedure.....	14
Preparing the anesthetic.....	14
Preparing the syringe.....	14
Preparing the queen.....	15
Ejaculation of drones.....	15
Filling the syringe.....	16
Injection.....	16
Cleaning and sterilizing the syringe tips.....	17
Disease as a factor in insemination.....	17
Estimating the number of sperm in the spermatheca.....	18
Laidlaw apparatus and method.....	19
Age of queen for insemination.....	21
Procedure for various objectives.....	21
Storing and shipping semen.....	22
Maintenance of queens.....	23
Maintaining queens in nuclei.....	23
Maintaining queens in nursery colonies.....	24
Rearing and maturing drones.....	24
Collection of drones for insemination.....	26
Control of parentage.....	27
Bibliography.....	27

Trade names are used in this publication solely for the purpose of providing specific information. Mention of a trade name does not constitute a guarantee or warranty of the product by the U.S. Department of Agriculture or an endorsement by the Department over other products not mentioned.

INSTRUMENTAL INSEMINATION OF QUEEN BEES

By Otto Mackensen and Kenneth W. Tucker, *Research Entomologists*,
Entomology Research Division, Agricultural Research Service

ABOUT THE HANDBOOK

This manual is intended to introduce instrumental insemination of honey bees to beekeepers, scientists, and technical workers in apiculture who want to learn the technique. A prior knowledge of bees, bee equipment, management procedures, and queen rearing is desirable for the student. However, an untrained person can master instrumental insemination and gain adequate experience in rearing queens and drones in

a relatively short time, under the guidance of one who is already experienced.

This publication brings together current information on instrumental insemination in easily readable form. This information has been gathered from the technical literature, the most important of which is listed under "Bibliography," on page 27, for those who want to study the subject in detail.

CONTROL OF MATING

The purpose of instrumental insemination in honey bees is to control matings. Since queens in nature mate away from the hive and in free flight, natural mating cannot be controlled except where one has absolute control of the drones flying in the area in which the queen mates. The flying drone population can be controlled only where complete isolation from other

bees can be achieved, as on small islands and in alpine meadows. The control of mating by confinement has been tried many times without repeatable success. Queen and drones do not mate within the hive, and most attempts to get queens to mate in enclosures have failed. By instrumental insemination any desired matings may be made.

DEVELOPMENT OF INSTRUMENTAL INSEMINATION

Instrumental insemination of queen bees did not succeed with the first attempt; rather it was paced by man's understanding of the structure and function of the reproductive systems of queens and drones. The first attempts at insemination, more than 180 years ago, probably failed because the mucus of the drone's ejaculate was thought to be semen. Not until 1920 was enough known of the reproductive organs of bees to start the development of a workable technique for instrumental insemination.

The techniques now employed had their beginnings in the late 1920's and early 1930's. In these first approximations, semen from one or two drones was taken up into a fine syringe and then part of the semen injected into a queen's vagina. Typical results were some partial inseminations:

queens, tardy to begin laying, that produced at least some fertilized eggs. But, occasionally, inseminations were good enough to encourage further effort.

By the late 1930's it was recognized that the semen was not placed deeply enough into the queen's reproductive tract. Obstructing further penetration is a tongue-like structure, the valvelfold. When it is moved out of the way, the syringe tip can be placed beyond it, and the semen discharged into the median oviduct. Placing the semen beyond the vagina and into the oviducts led to greatly improved results from instrumental insemination, even though partial inseminations were still too frequent, and queens were usually tardy to begin to lay.

It was soon discovered, during the early

1940's, that partial inseminations could be almost eliminated by injecting a larger volume of semen. Since that time, the semen of three to 10 drones per insemination has been used with consistently good results.

The problem of tardy onset of laying was solved about the same time. It was discovered that anesthesia of queens with carbon dioxide would hasten the onset of laying, not only of inseminated queens, but also of virgin queens. This discovery fits in well with insemination technique, because carbon dioxide is used to keep the queens still during instrumental insemination.

Along with the advances in technique, the equipment used for instrumental insemination was developed and improved into the two types of apparatus now used. Early means of holding

the queen still by tying her with thread to a wooden support was supplanted by queen holders of the tubular or clamp type in which the queen is also anesthetized. The technique of holding the sting chamber open and the sting from over the opening to the vagina by hand-held forceps was replaced by using hooks manipulated through friction mounts or by rack and pinion. For collecting and injecting semen, the screw type syringe with a fixed glass tip and a plunger extending into the tip has been modified into a disassemblable metal syringe with a plastic tip and a plunger extending not into the tip but pressing against a rubber diaphragm, which activates a column of saline solution within the tip. A probe, designed especially to move the valvelfold, has been used since the importance of the valvelfold was recognized.

STRUCTURE AND FUNCTION OF THE REPRODUCTIVE ORGANS

A knowledge of the reproductive organs of queens and drones is a basic requirement for anyone learning the technique of instrumental insemination, just as it was for those who developed the technique. The information presented here should fill this need.

The reproductive organs of bees are located in their abdomens, along with several other organs concerned with other bodily functions such as digestion and breathing.

Female Reproductive Organs

The female reproductive organs are illustrated schematically in figure 1. Figure 2 shows a posterior exterior view of the genital opening with the sting chamber opened as in preparation for insemination.

A large part of the abdomen is occupied by two ovaries (*O*), each consisting of long parallel egg tubules. Each ovary leads posteriorly into a lateral oviduct (*LOD*), which has accordion walls permitting great expansion for temporary storage of semen in newly mated queens and of mature eggs in laying queens. The two oviducts join posteriorly to form a short passage, the median oviduct (*MOD*), which in turn leads into the vagina (*V*). In instrumental insemination the end of the syringe must pass through the vagina and be placed in the median oviduct and

the semen discharged into the two lateral oviducts.

Above the vagina lies the *spermatheca* (*SP*), a thin-walled spherical structure about 1 mm. in diameter, which is filled with a clear liquid in virgin queens. It is covered with a network of tracheae, which gives it a white appearance. It is in the spermatheca that the sperm are stored for the life of the queen. The *spermathecal duct* (*SPD*) leads from the spermatheca to the dorsal wall of the vagina.

A tongue-like structure, the *valvelfold* (*VF*), projects into the vagina from its ventral wall. This structure can act as a valve to close the opening to the median oviduct when forced anteriorly against the forward wall of the vagina. It has transverse ridges which make it recognizable at times when it is exposed during instrumental insemination.

The vagina opens through the *vaginal orifice* (*VO*) into the anterior part of the sting chamber, the *bursa copulatrix* (*BC*), which is set off from the remainder of the sting chamber by a transverse fold in the ventral wall. In figure 2 this fold is stretched to form a triangle with the sting as its base. To either side of the vaginal orifice are two openings (*BPO*) that lead into a pair of pouches, the *bursal pouches* (*BP*). These openings can be mistaken for the vaginal

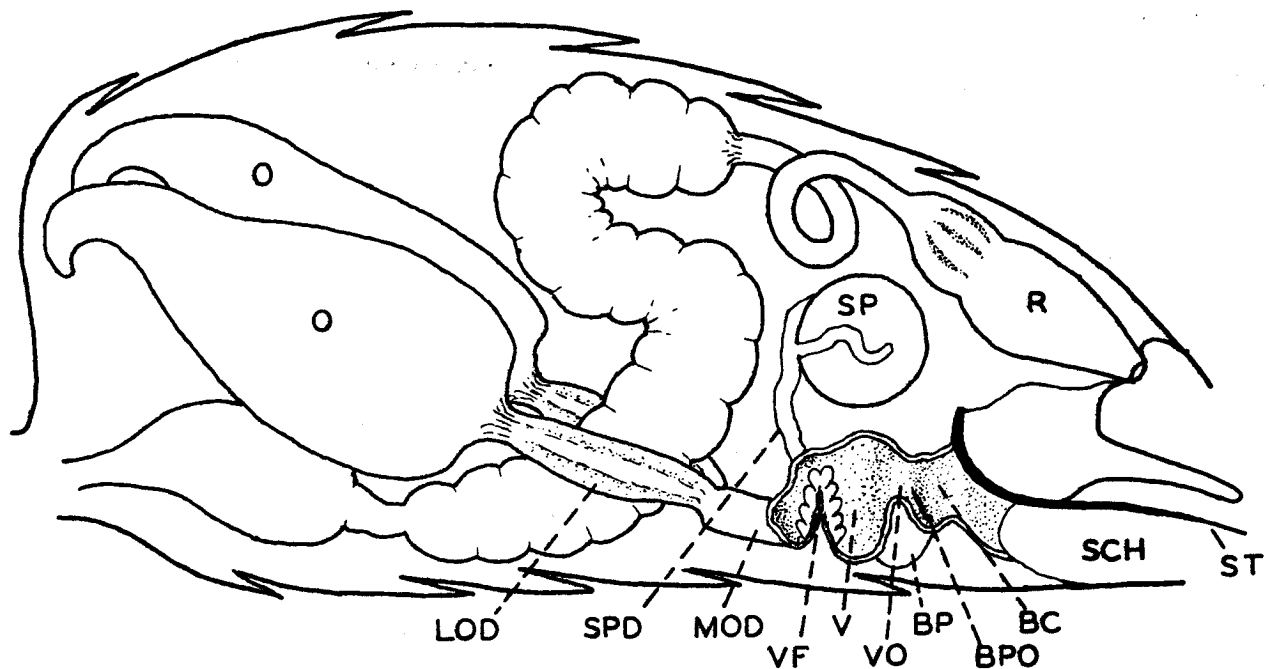

FIGURE 1.—Reproductive organs of the queen in approximately their natural position in the abdomen, with left side of vagina and bursa copulatrix cut away: *BC*, bursa copulatrix; *BP*, right bursal pouch; *BPO*, opening to bursal pouch; *LOD*, lateral oviduct; *MOD*, median oviduct; *O*, ovary; *R*, rectum; *SCH*, sting chamber; *SP*, spermatheca; *SPD*, spermathecal duct; *ST*, sting; *V*, vagina; *VF*, valvefold; *VO*, vaginal orifice.

orifice during instrumental insemination if the queen is not properly positioned.

In figure 2 the sting chamber is held open as in instrumental insemination by a *ventral hook (VH)* placed over the last *ventral plate (VP)* of the abdominal exoskeleton and a *sting hook (STH)*, which fits between the bases of the lancets of the *sting (ST)*. Here the reproductive tract has been compressed, the bursa copulatrix opened wide to expose the vaginal orifice, and the vagina collapsed so that the valvefold lies immediately inside the vaginal orifice and occasionally is visible without any probing.

Male Reproductive Organs

The male reproductive system is illustrated schematically in side view in figure 3, with the right-hand members of the paired structures not shown. Its principal paired structures are *testes*, *vasa deferentia*, and *mucous glands*. The *ejaculatory duct* and *penis* are single structures. In a young drone the testes are very large, slimy appearing organs that occupy almost the

entire upper half of the abdomen. They gradually shrink to small greenish-yellow structures in the sexually mature drone. A testis consists of small tubules which empty into a chamber at the end of the vas deferens. The vas deferens has a coiled section where it joins the testis and a long enlarged section, the *seminal vesicle*, which joins and empties into the lower end of the corresponding mucous gland. The two mucous glands unite at their lower ends into the narrow ejaculatory duct which leads to the penis.

The sperm cells go through development in the tubules of the testes and then pass into the vesicles where they remain until ejaculated. In the meantime the testes shrink.

The seminal vesicles have muscular walls and are lined with secretory cells that provide nourishment for the sperm. At 3 to 4 days of age a few sperm are already in the seminal vesicles, and at 4 to 5 days there are about 5 million and this increases to 10 to 11 million at 8 days. It is very important that drones receive proper care

during this period. Sperm obtainable at any age are usable in artificial insemination; however, it is best to wait until all sperm have had a chance to mature. This is considered to be about 12 days of age. There seems to be no deterioration of sperm as aging continues.

The mucous glands also have muscular walls with secretory cells. As the drone matures sexually these glands become distended and white from the amorphous white mucus secreted into the lumen of the gland.

The penis is a soft membranous sack with a

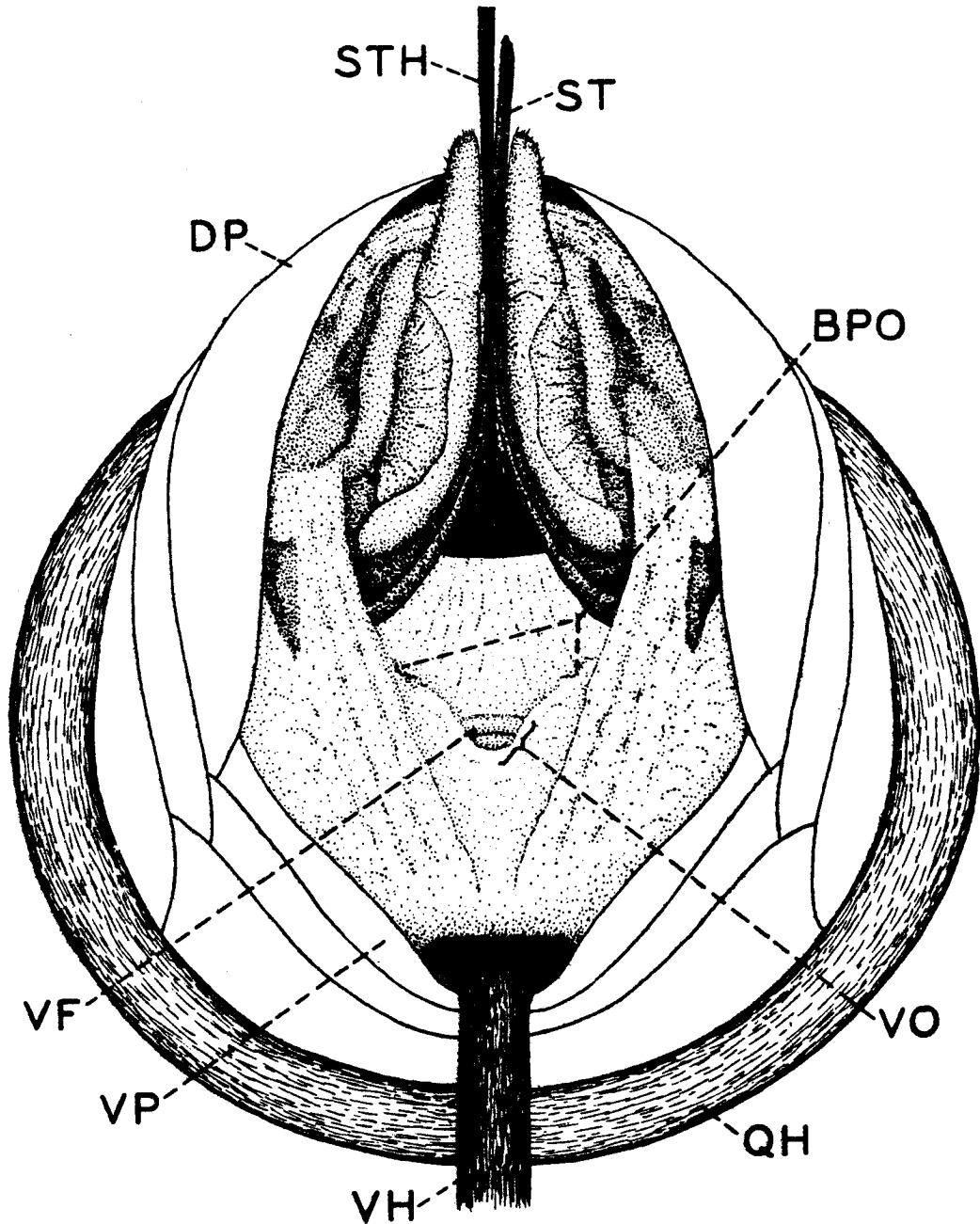

FIGURE 2.—Sting chamber of queen properly opened for insemination: *BPO*, opening of bursal pouches; *DP*, dorsal plate; *QH*, queen holder; *ST*, sting; *STH*, sting hook; *VF*, valvofold; *VH*, ventral hook; *VO*, vaginal orifice; *VP*, ventral plate.

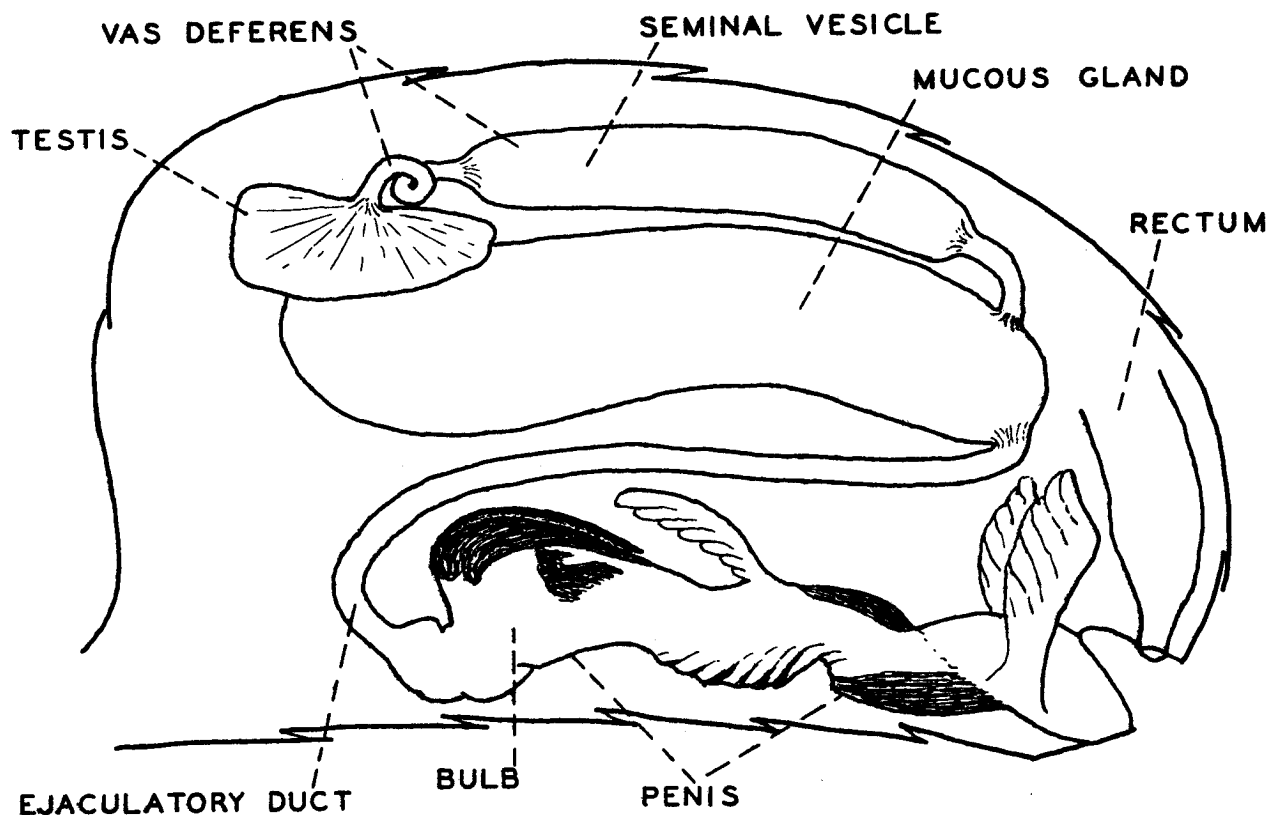

FIGURE 3.—Male reproductive organs in approximately their natural position in the abdomen. The right-hand members of the paired organs (testes, vasa deferentia, and mucous glands) are not shown.

number of bizarre processes and hairy areas. At its inner end it is enlarged into the *bulb* and provided with a pair of hard comma-shaped brown plates. The bulb is filled with a clear liquid which dilutes the sperm during ejaculation.

In mating the penis turns inside out to the outside of the body, pulling the ejaculatory duct through itself (fig. 4). This eversion is brought about by the simultaneous contraction of all the muscles of the abdomen. Ejaculation takes place during this eversion. A peristaltic contraction of the muscles of the seminal vesicles, beginning at their anterior ends, squeezes the sperm out through the ejaculatory duct; then the muscles of the mucous gland contract to push the mucus after the sperm into the bulb. These processes can be started by a number of artificial stimuli such as decapitation, pressure on the abdomen, chloroform fumes, or electric shock. When started in this way, the eversion usually stops at the stage illustrated in figure 4, A. With fur-

ther pressure on the abdomen, which must be applied to complete the eversion, the bulb passes on through a narrow section of the penis with a jerk, the points of the comma-shaped plates appear at the very end of the everted penis, and the semen and mucus are ejected from the bulb to the outside (fig. 4, B). In natural mating the transfer of semen to the queen is thought to take place at this stage. Under the artificial conditions of mechanical pressure on the abdomen, the eversion often proceeds still further until the bulb and its plates are turned completely inside out (fig. 4, C). Sometimes the internal pressure becomes so great that the penis explodes. In the technique of inducing eversion and ejaculation artificially, the aim is to stimulate muscle contraction and not to force the action. The sperm and mucus then come out in natural sequence with minimum mixing of the two. It is impossible to obtain a normal ejaculation by mechanical means alone.

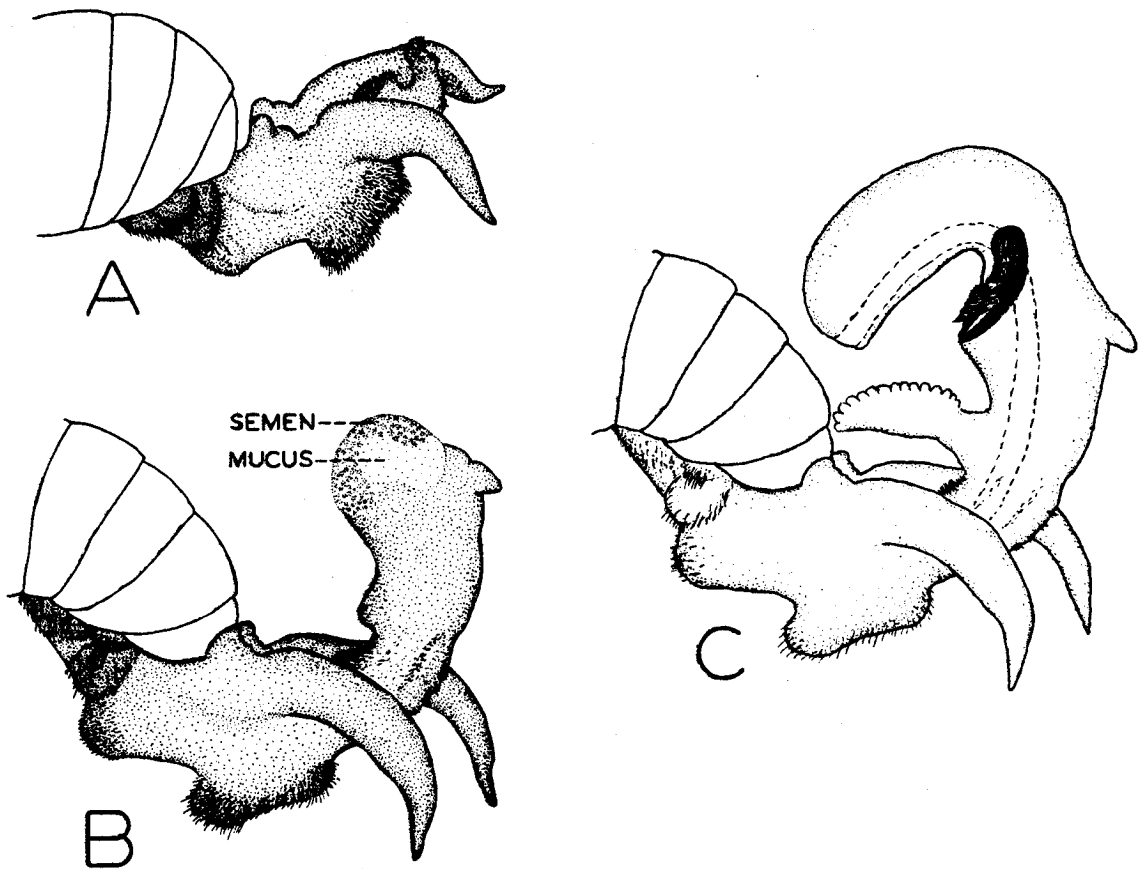

FIGURE 4.—Stages of the eversion of the drone's penis: *A*, Partial eversion usually encountered after initial stimulation; *B*, a more complete eversion usually obtained by squeezing the abdomen, with semen and mucus exposed; and *C*, a fully everted penis (semen and mucus not shown).

The semen is made up of the sperm plus liquids from the seminal vesicles and the bulb. The sperm are in bundles, giving the semen a cloudy or mottled appearance. This appearance together with its cream color makes semen easily distinguishable from the homogeneous

snow-white mucus. The semen becomes darker and contains more sperm as the drone ages; the best quality semen of dark-cream color, not mixed with mucus, is obtained from drones at least 12 days old. The quality does not seem to deteriorate with further aging.

NATURAL MATING

The natural act of copulation has been difficult to study, but considerable information has been obtained by examining queens immediately after their return from the mating flight. The queen evidently cooperates actively by opening the sting chamber and lowering the valvelfold voluntarily. The end of the penis enters the bursa copulatrix but not the vagina. Since the queen is not cooperating during artificial insemination, it may be necessary to lower the

valvelfold with a probe, to facilitate placement of the syringe tip in the median oviduct.

When the queen returns to the hive after mating, usually both oviducts are distended with semen, but often unequally. The anterior part of the vagina also contains semen, and some sperm have already reached the spermatheca. The bulb of the penis is found in the sting chamber or bursa copulatrix buried in mucus which also ex-

tends into the vagina, or the bulb may be absent.

During the course of the next 6 to 7 hours most of the sperm reach the spermatheca through the vagina and spermathecal duct, but some may remain in the oviducts 24 hours, especially after artificial insemination. How this translocation takes place is not yet perfectly understood. It has long been thought to be a process of active migration; however, while it is taking place, the queen frequently contracts her abdomen and little strings of dried semen are eliminated. From this evidence it has been assumed that the sperm is forced into the sperma-

theca during these contractions while the valvelfold serves as an imperfect seal of the vaginal orifice. Perhaps both processes play a part. Whatever the procedure, it is as effective after instrumental insemination as after natural mating.

Naturally mated queens, on return from mating flights, contain an average of 11.6 microliters (μl .) of semen in their oviducts (maximum 28 μl .). From this it is estimated that queens mate with eight to nine drones on the average (maximum: 17). If the first mating does not satisfy, the queen will mate a second or even a third time.

EQUIPMENT FOR INSTRUMENTAL INSEMINATION

The major equipment needed to perform the insemination operation is illustrated in figure 5. It consists of the *manipulating apparatus* (fig. 6) to which the *queen holder* (QH), *ventral hook* (VH), and *sting hook* (STH) and *syringe* (S) are attached in movable fashion, a cylinder of carbon dioxide for use as an anesthetic, a stereomicroscope, and a source of light. A jar in which queens are given additional treatments with carbon dioxide is also shown.

Microscope and Light

The microscope should be of the stereoscopic type with a wide field. The most desirable magnifications will vary with the operator. An experienced operator may prefer to use a single magnification of 10 to 15 diameters for both the collection of semen and insertion of the syringe. A beginner may wish to have also a higher magnification of about 20 diameters available for the insertion; the experienced operator might find 20 diameters useful with difficult queens. The experienced operator may be able to use an even lower magnification (6 to 7 diameters) so that the two operations can be performed under a single field without moving the microscope.

Some type of illumination is essential. A microscope lamp with a concentrated beam of adjustable brightness is best, but any lamp that gives sufficient light to satisfy the operator is satisfactory. The beam should be large enough to cover both the semen collection and injection operations without moving the lamp, or the lamp should be attached to the microscope so

the point of focus will always remain within the beam.

Carbon Dioxide Equipment

Carbon dioxide serves as anesthetic. It is obtainable in cylinders under high pressure which must be reduced to a few pounds per square inch by a reduction valve. If taken directly from the cylinder the gas will alternately freeze and thaw causing an irregular flow of gas. A needle valve permits adjustment of the flow to a very fine stream. A rubber tube carries the gas to the queen holder and another tube leads to a container in which queens are given additional anesthetizations.

Queen Holder

The queen holder (fig. 7) consists of an outer transparent plastic tube $1\frac{1}{2}$ inches long and an inner stopper (also a tube) of the same length to which the carbon dioxide supply tube is attached. The stopper is made of two parts that screw together permitting the insertion of a felt washer. This washer provides friction to keep the stopper in place and prevents leakage of carbon dioxide back around the stopper. The friction is adjustable to a limited extent. Screwing the parts together more tightly tends to increase the diameter of the felt washer thus increasing the friction with the tube. The queen is induced to back into this tube and when her abdomen begins to protrude she is secured with the stopper. The carbon dioxide flows through

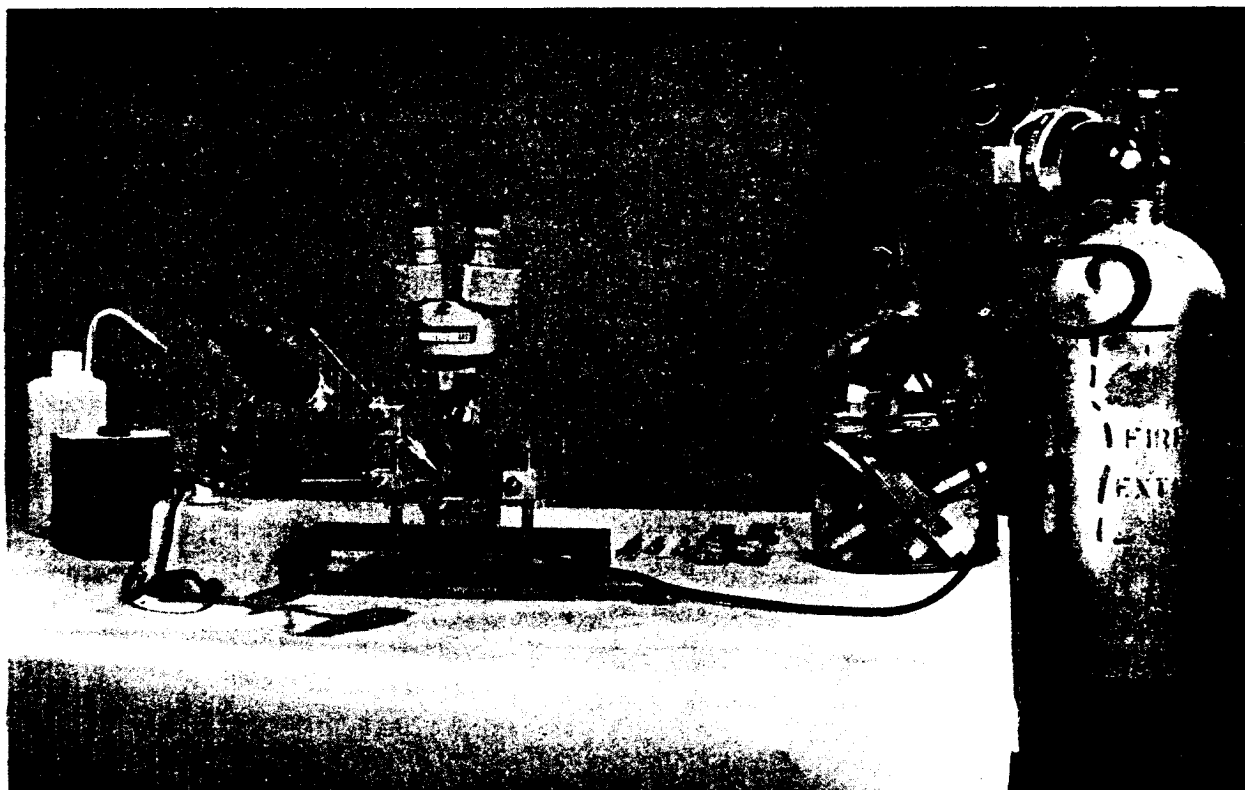

FIGURE 5.—Complete insemination equipment, showing manipulating apparatus under microscope with queen in place ready for injection of semen, jar for giving additional carbon dioxide treatments, and carbon dioxide cylinder with pressure regulator attached.

the hole in the stopper and bathes the queen as it passes out of the queen holder.

Syringe

Various types of syringes have been used during the development of the insemination technique. The Mackensen syringe (fig. 7) is the one most commonly used today. The barrel and plunger are made of stainless steel. The plunger is constructed in two parts so that when the screw plunger turns, the diaphragm plunger does not turn nor bore into the diaphragm. The diaphragm is made of rubber one-sixteenth inch thick. The tip and adapter are made of clear plastic. At its point the tip has an inside diameter of 0.005 inch and an outside diameter of 0.009 inch. This is about as small as the outside diameter can be made and still permit an inside diameter large enough for reasonably easy semen collection. Just inside the point, the in-

side diameter gradually enlarges for a distance of five thirty-seconds inch and then continues at a uniform bore of 0.031 inch. The tip is graduated in microliters and has a capacity of 10. With the 5/16-inch base, still larger capacities can be obtained by increasing the diameter of the uniform bore.

In operation the tip and adapter socket are filled with physiological salt solution, the tip is screwed into the adapter against the rubber diaphragm, and the adapter is then screwed into the syringe barrel socket. When the screw plunger is advanced, it causes the diaphragm plunger to push the diaphragm into the cavity at the base of the tip thus forcing the saline solution out. The semen is then taken in by retracting the screw plunger. Thus, the saline solution acts as a liquid plunger.

Originally the piece between the tip and barrel was the same diameter as the barrel and was

simply an extension that could be omitted. When the tip was screwed directly into the barrel a 1/2-inch-long diaphragm plunger was used. When it was found that the old style tips with 1/4-inch-diameter base did not have the capacity desired by modern workers, the base was enlarged to five-sixteenths of an inch and the connecting piece correspondingly. Thus, this piece became an adapter.

The adapter is a great convenience when sterilization is required as in a series of individual matings or to prevent the spread of disease. Several adapters and tips can be prepared, used one by one, and all cleaned and sterilized at the same time.

Sting Hook and Ventral Hook

Two hooks are used to hold the sting chamber open and the sting out of the way during the

operation. Each hook is secured to a long handle, which slides within its hook holder. The critical parts of these instruments are shown enlarged in figure 8. The ventral hook is mounted to the left of the operator and is little more than a bent wire that hooks over the ventral plate. The sting hook is mounted to the right of the operator. It has an enlargement at the end which fits into the triangular area between the sting lancets and extends underneath them (fig. 2). It is used to pull the sting dorsally exposing the vaginal orifice. These hooks may vary considerably in dimensions and shape, and different workers in instrumental insemination have their preferences. One should be prepared to make these hooks out of spring temper brass wire. Suitable tools for this purpose are number six cut files of round, oval, and flat shapes, obtainable from any jeweler.

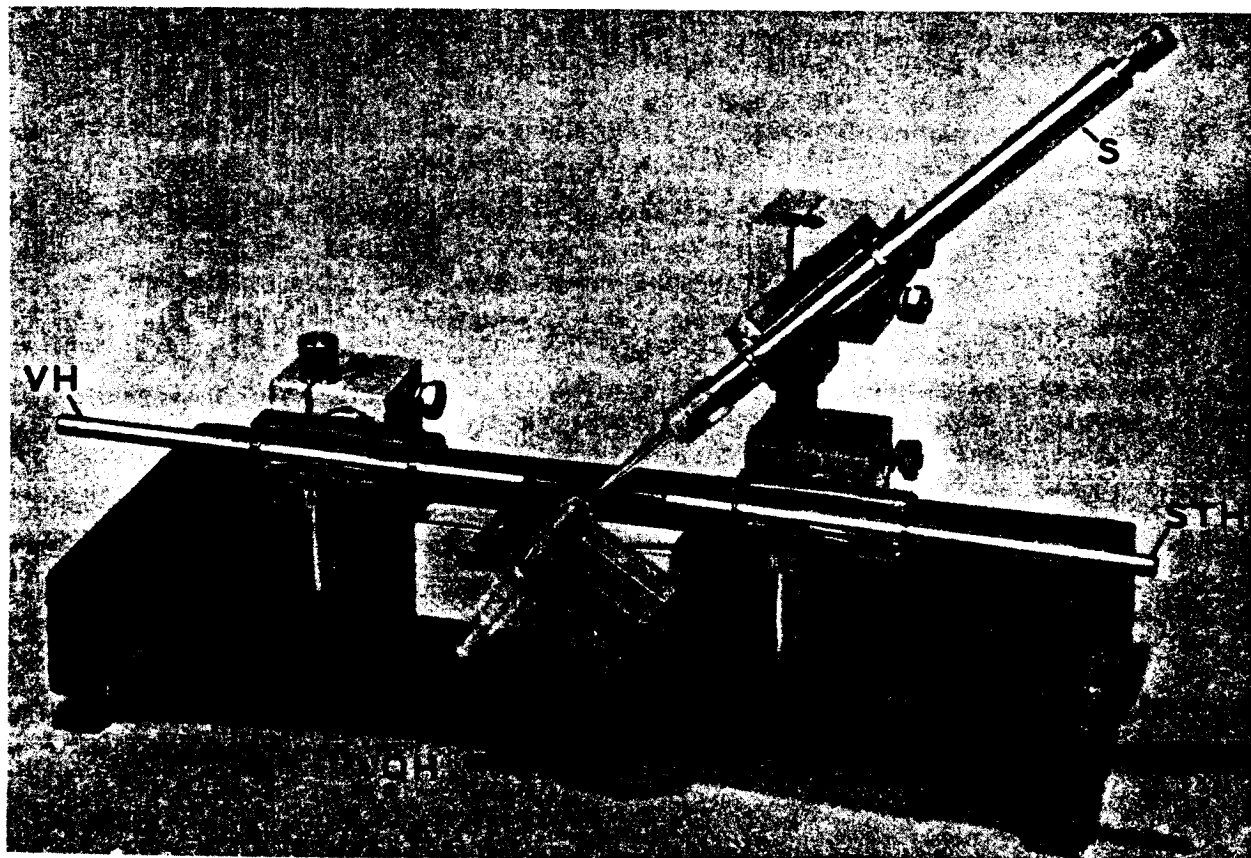
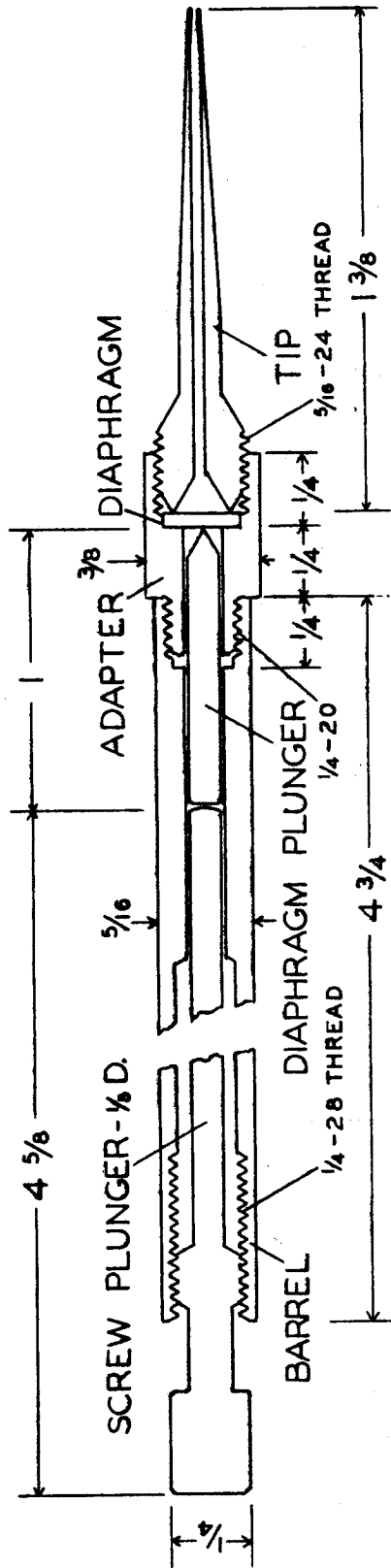
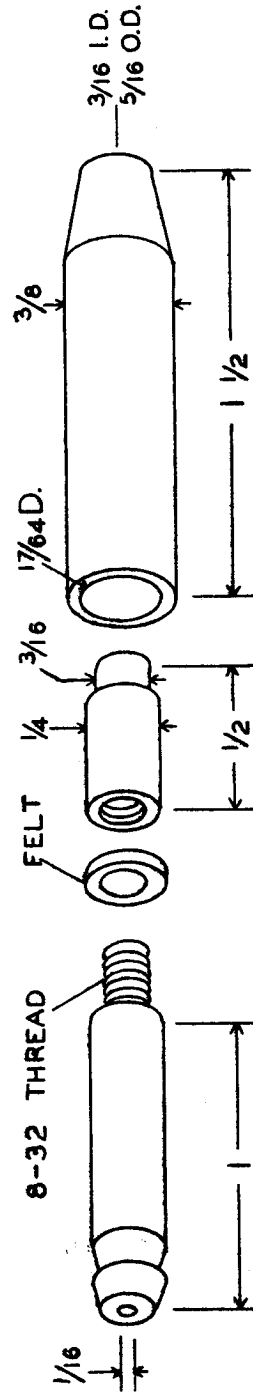

FIGURE 6.—Manipulating apparatus viewed from operator's side: *QH*, queen holder; *S*, syringe; *STH*, sting hook; and *VH*, ventral hook.



SYRINGE



QUEEN HOLDER

FIGURE 7.—Structural details of syringe and queen holder. Dimensions are in inches.

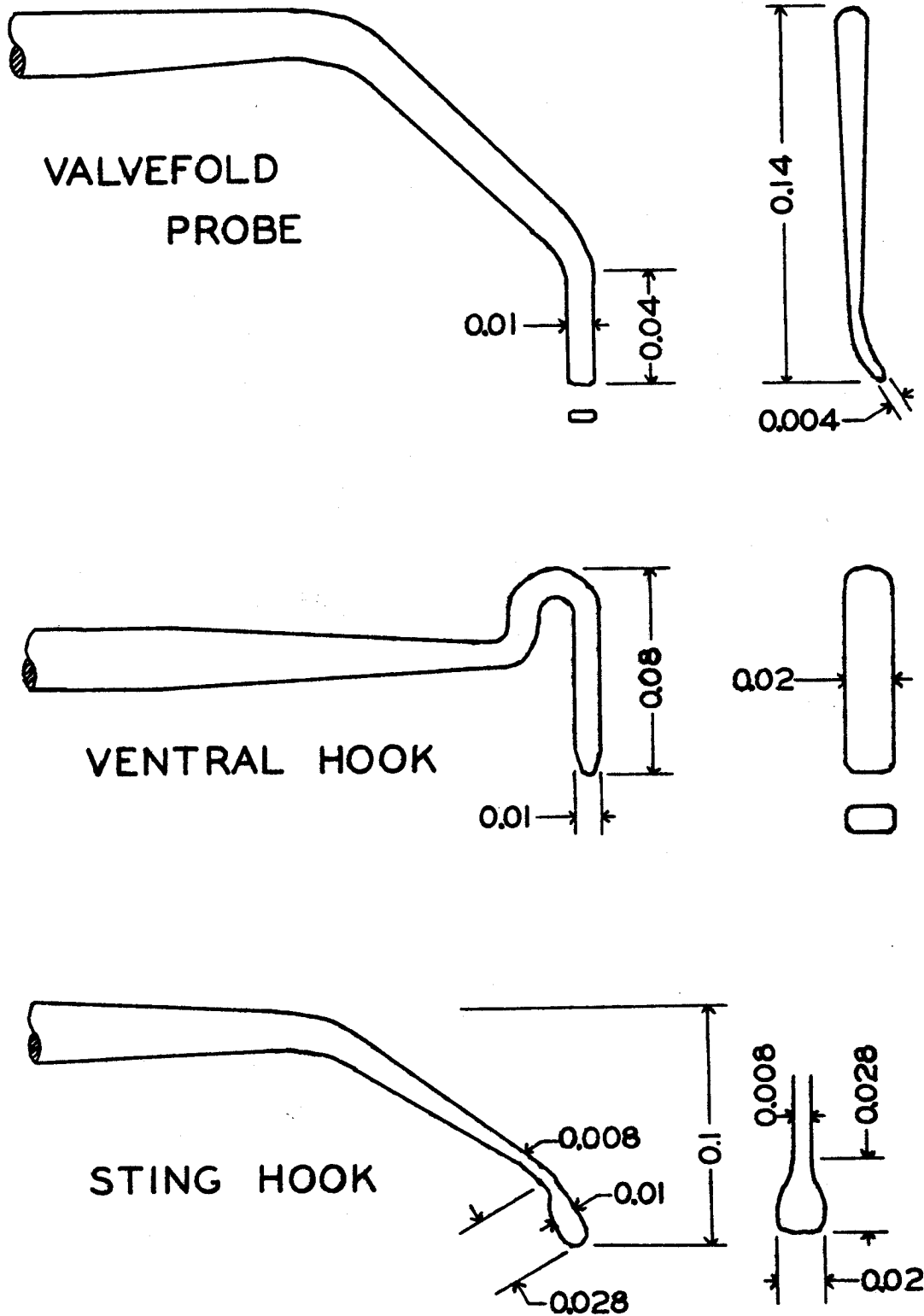

FIGURE 8.—Structural details of valvefold probe, ventral hook, and sting hook. Dimensions are in inches.

Valvefold Probe and Sting Depressor

The valvefold probe (fig. 8) is used to press the valvefold ventrally to make way for the point of the syringe on its way to the oviduct. There are two 45° bends on a plane with the main stem of the instrument instead of one 90° bend to minimize obstructing the view. The last 0.020 inch is bent counterclockwise about 30° when viewed toward the handle. The sting depressor is simply a needle that is used to depress the sting while the sting hook is placed. These instruments can be mounted in pin vices or other suitable short handles.

Manipulating Apparatus

A good manipulating apparatus will not only support the parts already described but will hold the syringe and holding hooks so that their functioning ends can be moved in any direction smoothly and easily and yet remain exactly where placed when released. The apparatus illustrated in figure 6 fulfills these requirements, and the position of its parts can be reversed for a left-handed operator.

It has a heavy base to which are attached the mounting for the queen holder in the center and $\frac{3}{8}$ -inch posts at either side $4\frac{1}{2}$ inches apart. The left post supports the ventral hook mounting and the right post, the syringe mounting (above) and the sting hook mounting (below).

The queen holder mounting block can be rotated in a vertical plane or moved from side to side. After it is once adjusted according to the wishes of the operator it is tightly secured. It is provided with a spring so that the queen holder can be simply and quickly snapped in place and moved up or down or revolved for accurate positioning while the tension of the spring holds the

queen holder in place. We suggest that the queen holder block be adjusted so that the queen holder leans 30° from vertical and makes a 10° angle with the syringe about as illustrated in figure 6 and changes be made later as desired.

Since the mountings for the syringe and holding hooks are similar, only the mounting of the ventral hook (fig. 9) will be described. The hook handle passes through holes in each end of a sheet metal holder. These holes are rounded at the bottom and inverted V-shaped at the top. A flat spring pushes the handle upward into the inverted V. The tension of the spring can be adjusted so that the hook handle can be slid in and out with just the right amount of friction. The hook holder is seated in a tapered depression in its support block so that it can rotate in a vertical plane. It extends through the block as a bolt and is held in place by a spring washer and two nuts. The degree of friction between the hook holder and its seat is controlled by the tension of the spring, which is adjusted by the inner nut. The outer nut locks the inner nut in place. The support block consists of two parts which clamp onto the upright post permitting rotation in a horizontal plane and adjustment up or down on the post. The parts are held together by two bolts with coiled springs under the nuts. The amount of friction with the post is controlled by adjusting the tension of the springs. This arrangement makes it possible to move the end of the hook in any direction quickly and easily and have it remain exactly in the position it was in when released. A split collar under the block is tightened around the post to hold the block at the desired level.

An insemination apparatus similar to the one just described is available commercially.

USE OF CARBON DIOXIDE

Carbon dioxide not only serves as an anesthetic, but also stimulates queens to begin laying. Proper treatment with this gas causes virgin queens, as well as instrumentally inseminated queens to begin laying practically as soon as naturally mated queens, whereas without such treatment only about 20 percent start earlier than 30 days after emergence.

At least two anesthetizations are necessary and a third may be given as a margin of safety without apparent harm. They may or may not be accompanied by insemination. An anesthetic treatment without insemination is given by placing the caged queen for 10 minutes in a convenient container through which carbon dioxide

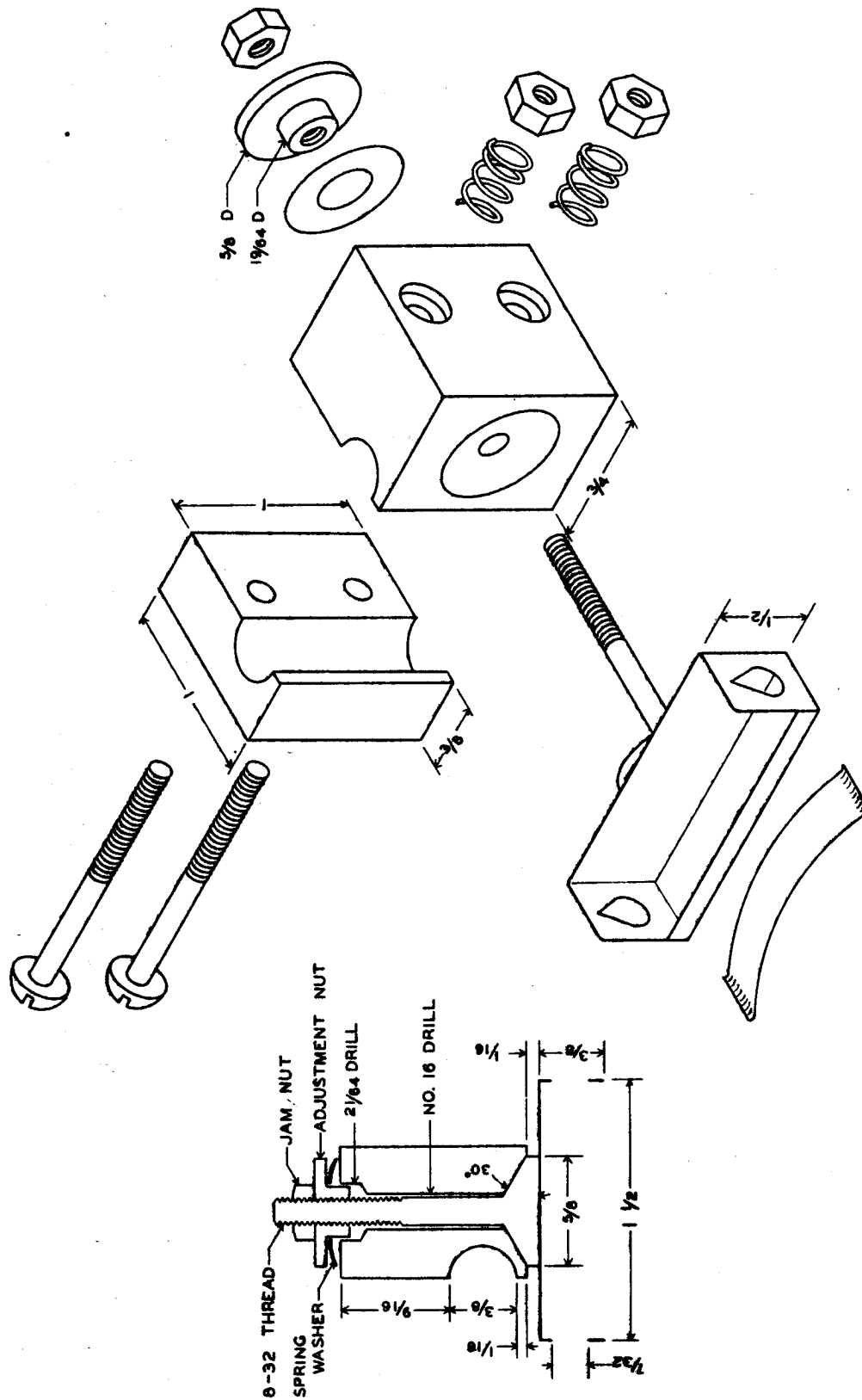

FIGURE 9.—Structural details of the ventral hook mounting with horizontal section through the principal axis. Dimensions are in inches.

is flowing (fig. 5). This gas is heavier than air, and as it fills the container from the bottom, the air is forced out through an escape tube at the top, insuring a high concentration. (Any wide-mouth container with a loosely fitted lid will suffice for carbon dioxide treatments.) Oviposition starts 2 to 6 days after the second treatment and a day or two later than would be the case after natural mating. Although treatments given as early as the second or third day are effective, they do not cause laying to start

earlier than the normal age. Since exposure during insemination may be too short or the anesthesia incomplete, it is recommended that two treatments be given after a single insemination and one treatment after two inseminations. These exposures to carbon dioxide appear to have no ill effect, but since anesthesia has been shown to change the behavior of worker bees, overexposure should be avoided. The minimum effective dose in time or concentration has not been determined.

INSEMINATION PROCEDURE

The best way to learn the insemination technique is to study under an experienced operator. A microscope arrangement permitting the student and the instructor to observe the same image is ideal.

Since an instructor may not be available, the procedure is here described in sufficient detail for the reader to learn the technique on his own. The description applies specifically to the apparatus that has just been described. The reader can adapt it to any other equipment he might be using.

The student's task will be made easier by the following suggestions:

1. Work with queens reared from several different breeder queens. Daughters of some breeders will be easier to inseminate than those of others. Try queens of different races if available.

2. Use queens reared under the most favorable conditions because large queens are easier to inseminate than small ones.

3. Use virgin queens that have had the free run of the nucleus and that are at least 7 days old. Such queens have less feces in their rectums than queens maintained any other way. A distended rectum pushes the reproductive tract ventrally making it more difficult to hold back the sting and to find the entrance to the median oviduct with the syringe tip.

4. Select a humid day if possible. In a dry atmosphere the exposed tissue of the queen will dry quickly making it more difficult to insert the syringe tip. Also, the semen may dry at the end of the syringe tip clogging the passage before it can be inserted or before semen can be taken from another drone. It may be necessary

to moisten these parts occasionally. An experienced operator will work so fast that he will have little difficulty, but a beginner may find these inconveniences very disturbing.

5. Practice the semen collection and injection procedures separately using water or saline solution instead of semen for the injection procedure.

Preparing the Anesthetic

The reduction valve of the carbon dioxide cylinder should be adjusted to a delivery pressure of about 5 pounds per square inch and the flow of gas to the queen holder stopper adjusted to a very small stream. It should be just enough to keep the queen quiet. The flow can best be judged by dipping the stopper in water.

Preparing the Syringe

The syringe is prepared by filling the syringe tip with a physiological salt solution to serve as a liquid plunger. A 0.9 percent sodium chloride solution is satisfactory. An antibiotic may be added to help prevent infection. A plastic squeeze bottle of the type used for dispensing liquids in laboratories is an aid in forcing the liquid into the tip. The socket of the adapter with diaphragm in place is then filled with the saline solution and the tip screwed into it firmly against the diaphragm. Be careful to exclude air because it tends to nullify the purpose of the liquid plunger. The extension is then screwed into the metal syringe body. By advancing the plunger, sufficient liquid is forced out to permit taking in the desired amount of semen when the plunger is retracted.

The syringe is placed in the syringe holder and swung around until the tip is away from the operator so that it will not interfere with the mounting of the queen.

Preparing the Queen

The queen is made to walk into a tube similar to the queen holder. When she reaches the constricted end she backs up, and if the queen holder is quickly put in place, she usually backs in readily. As soon as she reaches the constricted end of the queen holder, the stopper through which carbon dioxide is flowing is quickly pushed in after her (before she has a chance to move forward again). To be properly positioned the last three visible segments of the abdomen should protrude, and the hind legs should remain in the queen holder. A beginner may wish to insert a 3-way stopcock in the carbon dioxide supply tube so the gas can be diverted while the queen is placed. (If the queen's abdomen expands abnormally, the gas is being forced into her abdominal air sacs, an indication that the flow is too strong.) The queen holder is then put in place on the manipulating apparatus and adjusted so that the dorsal surface of the queen's body is to the right.

As soon as the queen is quiet, the sting chamber can be opened with the holding hooks, with the ventral hook to the left and sting hook to the right. The hooks are manipulated more or less simultaneously, but usually first the ventral hook and then the sting hook are inserted into the sting chamber and abdominal plates pulled apart. With the left hand, the sting depressor is used to hold the sting down while the sting hook is placed in the triangular area between the bases of the sting lancets, and left in this position to prevent unnecessary drying of the delicate tissues while the syringe is being loaded.

Ejaculation of Drones

Drones vary greatly in the ease with which they are induced to ejaculate and in the amount of semen delivered, especially when one is dealing with inbred drones. Some have no semen; others may not evert and ejaculate properly when the stimulation is artificial; still others

may evert so violently that the semen is projected and lost or the penis explodes.

The method commonly used to induce eversion and ejaculation is the following: The drone is decapitated and, if this does not cause a partial or complete eversion, he is grasped by the thorax with the thumb and forefinger of the left hand with the drone's ventral surface up. Then, while the anterior part of the thorax is squeezed with the left hand, the dorsal part of the abdomen is teased or repeatedly squeezed lightly with the thumb and forefinger of the right hand. This action usually brings about contraction of the abdominal muscles and a partial or sometimes a more or less complete eversion and ejaculation (fig. 4). If eversion is only partial (fig. 4, A), the abdomen is squeezed progressively from the anterior dorsal region to the posterior ventral part to continue the eversion by force until the semen is extruded (fig. 4, B or 4, C). Semen is rarely obtainable without abdominal contraction, but when the abdomen contracts without partial eversion, the eversion can often be completed by pressure and a good amount of semen obtained.

The amount of semen and mucus varies. The cream-colored semen comes out first followed by the thicker white mucus. Sometimes only semen is ejected, but usually at least some mucus comes out after the semen, and the two are distributed on the penis in various arrangements. Movement of sperm causes the semen to spread in a thin layer over the mucus, making it progressively more difficult to collect. Also, delay after the first stage of eversion makes the semen more difficult to collect, possibly due to a mixing of semen and mucus. It is, therefore, important to complete the whole procedure as quickly as possible.

Sometimes drones evert and ejaculate better if they are first induced to exercise by holding them by the legs with forceps while they attempt to fly or by permitting them to fly against a windowpane. Sometimes caging free-flying drones for a day or two improves eversion and ejaculation. Perhaps these methods increase the volume inside the abdomen by forcing air into the air sacs or by increasing the accumulation of feces; thus the contraction of the abdominal muscles is more effective in everting the penis.

Sometimes exposure to chloroform fumes is effective when all other methods fail; in fact, it is quite reliable in causing at least a partial eversion; however, an experienced operator will usually find this method too time-consuming.

Filling the Syringe

This operation is done under the microscope with the syringe tip swung a few inches toward the operator and the microscope moved correspondingly. The ejaculated drone is brought near the syringe tip with the left hand. The plunger of the syringe is withdrawn slightly to provide an air space (as small as practical—one-half microliter) between saline solution and semen and to facilitate measuring the amount of semen. The surface of the semen is then made to touch the point of the syringe at about a 45° angle. If the drone is pulled away from the syringe slightly without breaking contact, the semen will continue to adhere to the syringe and will flow toward it as the plunger is withdrawn. This procedure helps the operator to avoid taking up the mucus which is too thick to pass into the syringe tip and will stop the passage of semen. If mucus clogs the tip, the plunger is pushed out until the passage is cleared; then the taking of semen is resumed. By moving the drone about in relation to the syringe tip, the mucus can be skimmed of practically all its semen covering. Semen is taken from as many drones as necessary, and when the syringe tip is filled to the desired point a small amount of air or physiological salt solution is drawn in to prevent sealing of the end of the syringe tip by drying of semen. This air or salt solution can be injected with the semen without harm. The average yield of semen per drone is about 1 μ l. The beginner should take up semen very slowly; this is very important. Speed will come with experience.

Injection

The microscope is again positioned over the queen and the magnification changed to a higher power if desired. The sting hook is drawn dorsally until the sting chamber appears as in figure 2. Applying a 3 percent aqueous solution of Fast Green stain while the queen is in this position will help the beginner to recognize the vaginal orifice and possibly the valvelfold.

The syringe tip is then posed above the vaginal opening. With the left hand the valvelfold probe is inserted into the dorsal part of the vagina and the valvelfold is pushed ventrally until the point of the syringe has passed beyond (fig. 10). Then the probe is removed as the syringe is pushed in farther (about 1.5 mm.). If the surrounding tissue begins to move before the syringe has reached this depth, it is probably not in the oviduct. Sometimes the syringe needs to be moved ventrally slightly. The probe and syringe should be inserted only as far as necessary. Beginners have a tendency to insert these instruments too deeply.

Carefully attempt to inject the semen. If the column of semen does not begin to move immediately and the air between semen and saline solution begins to compress, the syringe is not in the median oviduct and must be withdrawn for another attempt. Some adjustments may be necessary. The dorsoventral centerline of the queen's body should be perfectly in line with the ventral and sting hooks, and the syringe should be inserted exactly in this centerline. If these precautions are observed, the syringe should enter the oviduct without difficulty. When the semen begins to move properly without any leakage around the point, the injection can proceed rapidly. Sometimes leakage can be stopped by inserting the syringe a little deeper, but if leakage continues, stop the operation and try again another day. When the injection is completed, the syringe is withdrawn and the queen removed from the queen holder.

Throughout the operation always steady the arms against the edge of the table and the hands and fingers against parts of the apparatus. Some operators object to use of the probe because it cannot be held steady enough to prevent injury to the queen. When we use the probe, we hold it steady by leaning the forefinger against the queen holder mounting.

If the probe is omitted, insert the syringe along the dorsal wall of the vagina; then move the syringe ventrally to push the valvelfold aside, and then inward again. Queens of some strains are easily inseminated without the probe.

Some operators load the syringe first while others prepare the queen first. The order is a matter of personal preference.

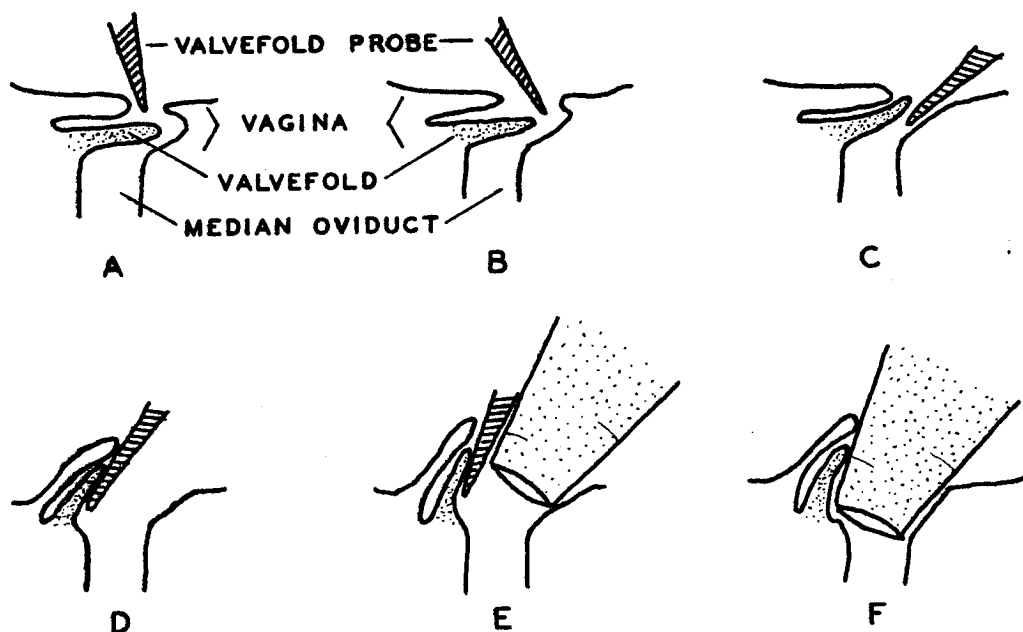

FIGURE 10.—Manner of pushing the valvelfold aside and inserting the syringe. (Redrawn from Laidlaw and Eckert, 1962, by permission of The Regents of the University of California.)

Cleaning and Sterilizing the Syringe Tips

The best way to clean and sterilize the syringe tips is to flush them with water and soak them in ordinary household bleach (active ingredient: sodium hypochlorite) used full strength. Soaking overnight in this material loosens adhering semen so the tips can be flushed clean the following day. This material also sterilizes and does not affect the plastic. A fine wire, 0.005 inch or less in diameter, should

be available in case the syringe tip does become clogged. The wire should be cut off squarely and have no sharp edges to damage the soft plastic.

Ordinarily, aseptic methods are not necessary. When changing from one type of sperm to another, the syringe tip can be cleaned and any adhering sperm killed by rinsing thoroughly with water. Precautions to be taken when paralysis or septicemia are present in the apiary are outlined next.

DISEASE AS A FACTOR IN INSEMINATION

There are two adult bee diseases to contend with in instrumental insemination—septicemia and paralysis. Neither one is considered a very serious disease under ordinary apiary management, but in instrumental insemination they can cause disastrous losses if not controlled.

A queen that has contracted septicemia during insemination will die a day or two later and soon show the typical symptom of this disease: dismemberment of the body parts. If this bacterial disease is suspected but the symptoms are not yet evident, hold the queen a day under humid conditions. If the queen's legs and wings

are then not pulled off easily (practically fall off), then the trouble is not the type of septicemia common in the United States. Other septicemias that do not cause dismemberment have been reported in Europe and would probably also be spread by insemination.

Septicemia is spread by instruments that come in close contact with the queen: syringe, sting hook, and valvelfold probe. Contaminated ventral hook, queen holder, and hands are not likely sources of infection. The semen of drones dying of septicemia seems to be uncontaminated.

Paralysis is caused by a virus. It kills less rapidly than septicemia. Infected queens returned to their nuclei after insemination may simply not lay and disappear after a few days. Others gradually become sluggish and bloated with clear body fluid. In this condition they will live for several days on the comb or on the bottom board. Some will lay a few eggs before they become sick.

These diseases can usually be avoided by using free-flying drones of any age or confined drones as soon as they are sexually mature or at least within 3 weeks after emergence. Whenever they have appeared, we have controlled these diseases by instituting sterilization procedures. Between each operation or after every third operation, the plastic syringe tip was sterilized with sodium hypochlorite, and the probe and sting hook were sterilized with 70 percent alcohol.

Antibiotics have been used by a number of workers and can be used routinely. At the Bee Research Laboratory, Tucson, Ariz., Terramycin

is used. A stock solution is made up with 2.5 grams Terramycin (poultry formula—6.25 grams activity in one-quarter pound) in 100 cc. physiological sodium chloride solution and refrigerated. The stock solution is diluted with eight parts of the salt solution as needed. In loading the syringe with semen, a microliter of the Terramycin solution both precedes and follows the semen. All this is injected, and, as the syringe is withdrawn, an additional microliter of the Terramycin solution is placed at the opening of the reproductive tract before removing the sting and ventral hooks. The syringe is used continuously without cleaning. In a similar method, we substituted 0.25 percent streptomycin sulfate for the Terramycin. At the Bee Management Investigations Laboratory at Madison, Wis., streptomycin sulfate (0.5 grams per cc.) is applied with a brush to the hooks and loaded syringe just prior to insertion of the syringe.

These methods control septicemia. In the case of paralysis, sterilization procedures may be necessary because it is a virus disease.

ESTIMATING THE NUMBER OF SPERM IN THE SPERMATHECA

The success of an instrumental insemination can be measured by the number of sperm reaching the spermatheca. To dissect out the spermatheca for examination, the last visible segment of the abdomen is torn off by grasping the last ventral plate with forceps. The spermatheca is usually found embedded in tissue inside this removed segment. It is a sphere about 1 mm. in diameter and appears rough and white because of the net work of tracheae which covers it completely. The spermatheca is lifted onto a finger and the tracheae removed by rolling with the forceps. The spermatheca itself is smooth and transparent in a virgin queen; and in mated queens it varies from translucent through milky-white to cloudy and a dark cream color depending on the number of sperm present. With up to 0.5 million sperm it ranges from clear to opaque milky. When the number reaches 0.8 to 1.0 million it becomes slightly cloudy. At 1.5 million it is cloudy and light cream colored. As the number increases it becomes dark-cream colored.

A more accurate estimate can be made by counting the number of sperm in a sample taken

from the diluted contents in the following manner.

Equipment needed includes a counting-chamber slide, a 10-cc. pipette, a medicine-dropper pipette, a small dish holding a little more than 10 cc., a pair of forceps, and a dissecting needle.

The spermatheca is placed in the dish, and 1 cc. of 0.9 percent sodium chloride solution added. Then the spermatheca is broken with the forceps and needle, the sperm teased out, and the empty skin removed. The sperm is dispersed by alternately drawing the saline solution into and expelling it from the medicine-dropper pipette until all lumps have disappeared. Then 9 cc. of tapwater is added to make a total of 10 cc. and the sperm again thoroughly dispersed with the medicine-dropper pipette. A drop of this mixture is quickly placed in the counting chamber.

In the saline solution the sperm appear as headless filaments about 0.25 mm. long and are easily dispersed. The tapwater kills them, but before they die most of them coil up into various shapes such as small circles or configura-

tions resembling the numerals 6 and 8. In these forms they are more easily counted than when relaxed. They are most easily seen and counted under a phase-contrast microscope or one with a dark field. The number in 10 cc. is calculated from the number counted in a given volume.

The number of sperm in the seminal vesicles of drones can be estimated by the same method. A window is carefully cut into the dorsal wall of

the abdomen and the seminal vesicles very gently cut off where they join the mucous glands. If this is not done very carefully, the muscles of the seminal vesicles will contract prematurely and some of the sperm will be lost. After being placed in the saline, the muscles are made to contract by pricking and mashing, and what sperm is not forced out in this way is released by tearing the vesicles to pieces.

LIDLAW APPARATUS AND METHOD

The Laidlaw apparatus for instrumental insemination (fig. 11) differs from that of Roberts and Mackensen in the way the queen is held and in the way the movement of the holding hooks and syringe is controlled by means of racks and pinions. The track on which the syringe is advanced is fixed, so that the queen is positioned beneath the syringe by moving the whole queen manipulator which holds the queen. The operation of instrumental insemination is quite similar to that with the Roberts and Mackensen apparatus.

The Laidlaw apparatus consists of two parts, a queen manipulator and a syringe manipulator.

The queen manipulator has a heavy circular base whose bottom surface is smooth and slides easily on the glass stage of a microscope for positioning the queen in relation to the syringe. The remainder of the queen manipulator is connected to the base by a ball and socket joint, which is tightened to a fixed position of optimal alinement of the queen to the syringe. The holding hooks are mounted by chucks on vertical racks and pinions, which in turn are mounted on horizontal racks and pinions to either side of the centrally located queen holder, with the sting hook to the right and the ventral hook to the left when the control knobs face the operator. The queen holder consists of two vertical surfaces, the left one fixed and the right one moveable. Pieces of foam rubber glued to each of these surfaces from the pads between which the queen is clamped. The moveable surface can be moved back and forth by a rack and pinion. The fixed surface is recessed into a block, so as to make a closed anesthetization chamber about the queen when she is clamped in position. Carbon dioxide gas is directed toward the queen's thoracic spiracles from ports

located in either side wall of the chamber.

The syringe manipulator consists of a rack and pinion tract to which the syringe is clamped and permits movement up and down at the adjusted angle. The syringe manipulator is mounted from a post attached to the front of the microscope stage. The attachment from the post to the syringe manipulator includes joints by which the syringe manipulator may be adjusted to the correct angle in relation to the queen, but tightened securely once this adjustment is made.

The approximate alinement for the Laidlaw apparatus is with the queen manipulator tilted about 10° to the right of vertical, and the syringe manipulator about 20° to the right of vertical. The syringe tip should enter the queen's reproductive tract directed slightly towards the queen's ventrum about 10° from the queen's long axis. When the queen is positioned for insemination, the syringe and queen manipulator should be alined across the stage of the microscope in a line with the queen's dorsum towards about 1 o'clock and ventrum towards about 7 o'clock.

Because the alinement of the Laidlaw apparatus differs from that of the Roberts and Mackensen apparatus, the construction of holding hooks and of the valvifold probe differs.

Detailed plans for the Laidlaw insemination apparatus are available from Dr. Harry H. Laidlaw, Department of Entomology, University of California, Davis, Calif. 95616.

With the Laidlaw apparatus, the operation of instrumental insemination consists of the same steps as with the Roberts and Mackensen apparatus, but the details of how some of these steps are accomplished differ. The major differences are the following:

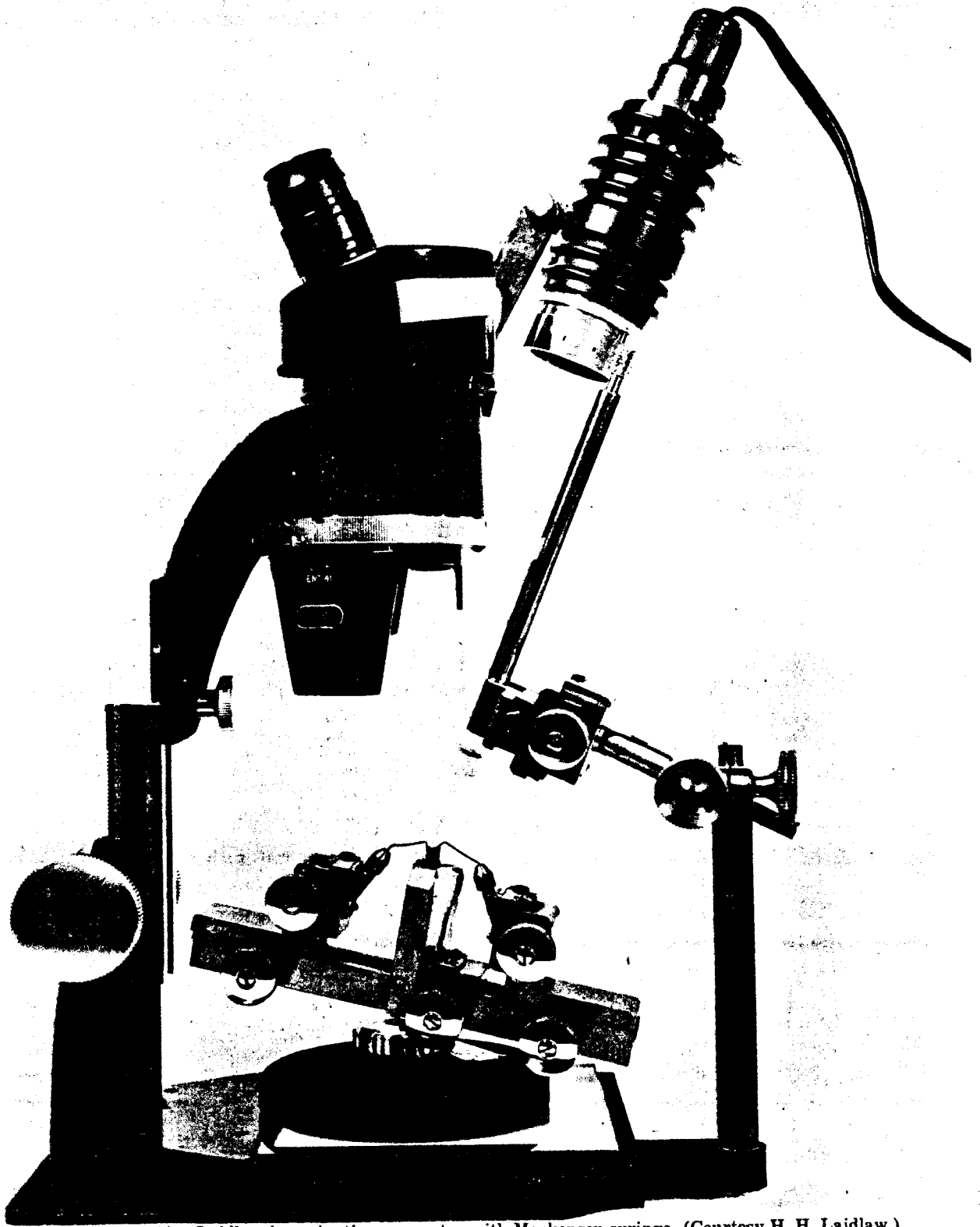

FIGURE 11.—Laidlaw insemination apparatus with Mackensen syringe. (Courtesy H. H. Laidlaw.)

Placing the queen into the queen holder is done with the queen already anesthetized, by holding the queen in one's hand along with a tube delivering carbon dioxide. The motionless queen is then grasped gently with one's left hand by the anterior part of her abdomen and suspended, head downward and dorsum to the right, into the opened queen holder, so that her dorsoventral body axis is in a straight line with the holding hooks and with her thorax opposite the foam rubber pads. The queen holder is then closed by turning the control knob with one's right hand until the queen is firmly clamped into position. Placing the queen into the queen holder is done while the queen manipulator is on the laboratory table to the left of the microscope; the action is easily done without magnification.

With the queen manipulator placed onto the stage of the microscope, the sting chamber is opened and kept spread open with the sting depressed with a pair of fine jeweler's forceps held in one's left hand. The sting hook and then the ventral hook are positioned by turning the

appropriate control knobs for the racks and pinions, after which the forceps are withdrawn.

The queen is oriented in relation to the syringe by sliding the queen manipulator on the glass microscope stage. Since the syringe can be moved only upward and downward, and cannot be tilted or moved from side to side, even the final adjustment to get the syringe tip in position for insertion is made by moving the queen manipulator.

Inserting the syringe tip into the median oviduct with the Laidlaw apparatus differs only slightly from that operation with the Roberts and Mackensen apparatus. In moving the valvefold, the operator moves it toward 7 o'clock, rather than toward 9 o'clock. The syringe is advanced and withdrawn by turning the control knob for the rack and pinion on the syringe manipulator. Also, since the queen is nearly vertical, the valvefold is seen more readily, and one can often see through the vagina to the opening of the median oviduct when the valvefold is moved.

AGE OF QUEEN FOR INSEMINATION

Whenever possible, inseminations should be made at the normal mating age of the queen, around the seventh to 10th day after emergence. We have inseminated queens successfully in quantity as early as the fourth day. They can be inseminated at any later age so long as they have not started laying. The minimal interval between two inseminations should be 1 day, and a 2-day interval will permit a more

complete clearing of the reproductive tract when very large doses of semen are given. In this connection, oviposition may start as early as 2 days after the second exposure to carbon dioxide. There is some evidence that when development is retarded by cool weather, inseminations are more successful at 10 to 12 days than earlier.

PROCEDURE FOR VARIOUS OBJECTIVES

The number of inseminations and volume of semen will depend upon the objective of the inseminator and the time and effort he is willing to expend. Usually only one or two inseminations are made. The efficiency, that is the percentage of sperm reaching the spermatheca, decreases as the amount of semen injected increases. After insemination with 2 to 20 microliters of semen, the percentage of sperm reaching the spermatheca will range from about 15 to 4, respectively. Results will vary with the stock used.

In bee breeding and genetic studies it is often necessary to inseminate a queen with semen from a single drone. For best results with such individual matings, well-nourished drones reared in large cells in relatively new drone comb should be available and only those utilized that ejaculate perfectly and yield a large quantity (1.25 to 1.5 μ l.) of dark cream-colored semen. Results will depend upon the stock used. One might expect about 10 to 15 percent of queens to be partial or complete "drone layers" immediately and more to become "drone layers" later. Some may lay fertilized eggs two seasons

in a nucleus. The spermathecae of 17 queens killed soon after insemination contained an average of 0.87 million sperm (range: 0.22 to 2.24), about one-sixth the number found in naturally mated queens.

If a queen is expected to produce fertilized eggs for a few months only and individual mating is not required, an insemination with semen from three to four drones (3 to 4 μ l.) will be sufficient. Average spermathecal sperm counts of 2.9 and 3.6 million have been reported after insemination with 4 μ l.

If a queen is to head a large colony for a year or more, it is logical to attempt to duplicate the number of sperm a queen receives in a completely satisfying natural mating. On the average, naturally mated queens receive about 5 million sperm in their spermathecae. Experiments have shown that queens that have no desire to make further mating flights after their first mating contain an average of 5.3 million sperm in their spermathecae. Further experiments have shown that queens do not mate naturally after instrumental insemination with 8 microliters semen, but do fly out for further mating if given smaller amounts. The number of sperm reaching the spermatheca with a dose of 8 μ l. semen has been reported as 3.16 and 5.4 million in different experiments. Although the number of sperm reaching the spermatheca increases as the dose increases, diminishing efficiency makes it hardly worth while to give more than 8 μ l. of semen in a single insemination. Also, with higher amounts the danger of injury is increased. In some experiments a high death

rate was obtained with single inseminations of 12 μ l; in others, 18 μ l was the maximum given without injury.

If a certain quantity of semen is given in two inseminations of equal amounts instead of in one insemination, the number of sperm reaching the spermatheca will average about 15 percent greater. (Increases of 1 to 41 percent have been reported.) Another advantage is that variability will be lower. These advantages must, however, be weighed against the additional effort involved and the additional chance of injury during the second insemination.

The percentage of laying queens obtained will vary with stock used, but an experienced operator should be able to obtain 90 percent laying queens after either one or two inseminations during the most favorable part of the season if the stock is vigorous and disease is absent. Properly inseminated queens have been shown to perform as satisfactorily in brood and honey production as naturally mated queens.

Queens that are already laying can also be inseminated, but egg production must first be reduced. The technique is most commonly used in mating a queen with her own drones to attain a high rate of inbreeding. The virgin queen is first induced to lay by treating with carbon dioxide. When her drones are mature she is caged away from her colony with a few attendant bees for about 4 days to stop or retard egg development. Then she is inseminated as usual but with small amounts (3 μ l. or less) of semen to avoid congestion in the oviducts in case some eggs are still being produced.

STORING AND SHIPPING SEMEN

Semen can be shipped long distances for use in instrumental insemination. Successful inseminations have been made with semen shipped between the United States and Europe and between the United States and Brazil.

The technique is as follows: The semen of many drones (30 to 40) is placed in a 2 mm. diameter capillary tube, a syringe load at a time, and centrifuged just enough to force the semen down to the closed end and eliminate air spaces. Mucus must be scrupulously avoided. The open end is then sealed over a flame 5 to 8 mm. above the semen while care is exercised not to over-

heat the semen and at the same time leaving a minimum air space. Properly protected, such tubes of semen can be sent by airmail in an ordinary letter envelope. To use the semen, the tube is broken in such a way that the first 1 to 2 mm. of semen next to the air space is discarded and the remainder of the semen is taken into a syringe as usual.

By similar methods, but with antibiotics added (streptomycin sulfate or tetracycline hydrochloride), some of the sperm has remained capable of fertilization for 16 to 18 weeks.

MAINTENANCE OF QUEENS

Queen rearing will not be dealt with here except to emphasize that large queens are more easily inseminated than smaller ones and that if one spends the effort involved in instrumental insemination one should start with the best. For queen rearing methods the reader is referred to the many books that have been written on the subject.

There are several ways to maintain queens for instrumental insemination. Some methods, which the reader can modify to suit his convenience, are described below:

Maintaining Queens in Nuclei

A method we use is as follows: Mature queen cells are placed in vials (fig. 12, *A*) and kept in an incubator at 35° C. until emergence. The neck of the vials is just large enough to receive the cells, but not the wooden cell bases to which they are attached. In the bottom of the vials is placed a ¼-inch layer of coarse sawdust or fine wood shavings, to absorb moisture, and a small pellet of queen candy. As the queens emerge a wing is clipped on each and a color mark placed

on the dorsum of the thorax for identification of mating groups. They are then confined to holding cages (fig. 12, *B*) and placed individually in the center of the brood nest of previously prepared nucleus colonies. The nuclei are "baby" frame size (9½-inch top bar; 6¼-inch depth) and when first established, are composed of a comb each of honey and brood plus two empty combs and ¾ to 1 pound of bees. Before adding them to the nuclei, the bees are sifted through a queen excluder and all drone brood is killed to eliminate drones that would otherwise clog the excluders, which must be kept over the entrances until the queen starts laying. The brood is examined between the seventh and 10th day after the nuclei were made up, and all emergency queen cells are destroyed. The queens are taken to the laboratory in their cages, several at a time in convenient numbers for each insemination or carbon dioxide treatment. After the last treatment, each queen is returned to her nucleus by simply dropping her into the cluster of bees while still anesthetized, or the cage is opened and placed into the nucleus

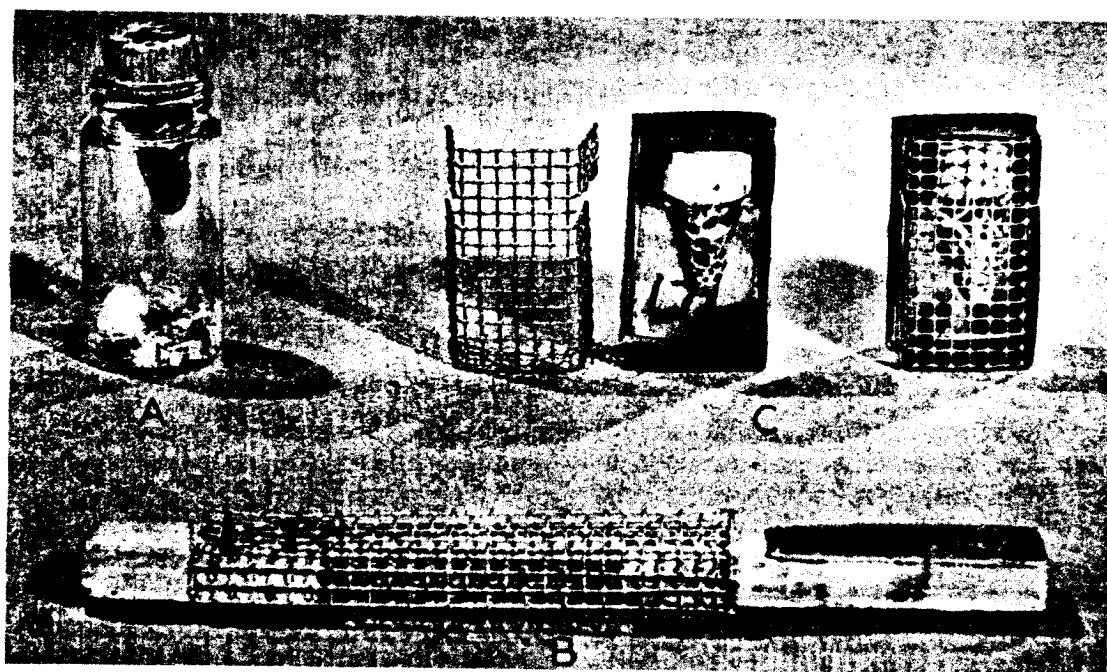

FIGURE 12.—Containers used in queen handling: *A*, Vial used for queen emergence in an incubator; *B*, cage for holding queens individually in nuclei; and *C*, cage used for queen emergence in an incubator and for emergence or storage in nursery colonies.

to be removed later when the queen has revived. In cool weather the cage is opened and placed within the cluster. Nuclei in which queens are lost are removed from the queen yard. Only nuclei from which laying queens have been recently removed are reused.

If the queens are permitted to run loose in the nuclei, it is best to put the queen cells directly into the nuclei and clip and mark the queens as soon as they emerge while they are still recognizable as newly emerged queens. This method requires spending some time finding the queens, and there is always the risk of a stray queen being mistaken for the desired one. An advantage is that the virgin queens destroy any emergency queen cells that have been started.

The nucleus hives we use have room for 11 combs. We start the nuclei with four combs and add more as needed. We find the extra space convenient during insemination and carbon dioxide treatment. By adding supers these nuclei can be permitted to develop into small colonies suitable for wintering breeder queens.

Maintaining Queens in Nursery Colonies

When queens are maintained in nursery colonies, the mature queen cells are put into individual cages (fig. 12, C). The cages are placed into holding frames, which are put into a strong queenless colony. Only virgin queens are kept in

this colony. The virgin queens emerge into the cages and are fed by worker bees through the mesh of the cages. When about a week old, the virgins are taken from the nursery and inseminated. After insemination, the queens are each caged with a few worker bees and kept in another nursery colony for at least 2 days. A day after the nuclei to which they will be introduced have been made up, the inseminated queens are given a treatment with carbon dioxide and introduced into nuclei. These queens should be introduced so that they are not released until they are ready to lay.

The nursery for the virgins and that for the inseminated queens are made up and maintained similarly to queenless cell builder colonies. There should be an abundance of bees, honey and pollen, and two combs of unsealed brood renewed each week. The caged queens should face the unsealed brood. The nursery should be fed sugar syrup and pollen in the absence of natural nectar and pollen flows.

The advantage of maintaining queens in nursery colonies is that the queens are quickly located for inseminations and carbon dioxide treatments. The main disadvantage is that the queens may have excessive accumulation of feces in their rectums and be difficult to inseminate. Also, loss of queens during introduction is a problem with this method.

REARING AND MATURING DRONES

Inducing a colony to produce drones is not always easy. Young queens are often more reluctant to lay drone eggs than older ones. There is considerable variability among stocks and individual queens in the ease with which drone eggs are obtained. Early in the season drones can usually be obtained in abundance from any queen because they are naturally produced at this time of year in preparation for swarming. Later in the season and during pollen dearth periods, colonies are often very reluctant to produce drones. At such times it may be necessary to stimulate them by feeding pollen and syrup with pollen added, and creating a crowded condition by adding bees or reducing the size of the hive. At times when the nectar flow is extra heavy the bees will fill the drone comb with nectar. At such times the queen can

be restricted to one brood chamber below an excluder and dark empty combs placed above. By extracting the drone comb gently, the thin nectar can be removed without destroying eggs and young larvae that might be present in some of the cells, thus giving the queen a greater opportunity to lay in the drone comb. The queen can be forced to lay on a drone comb by confining her to the comb within a queen excluder cage; however, one might be disappointed to find that the queen has deposited only fertilized eggs. It is best to create conditions that make the queen desire to deposit unfertilized eggs.

The importance of pollen for rearing and maturing drones cannot be overemphasized. While an abundance of pollen stored in combs often seems to suffice, some operators insist on adding more pollen in the form of moist pollen

cake (without nonpollen extenders), or 25 to 50 percent pollen in sugar syrup. Pollen syrup is better sloshed daily over the top of the frames, where it will be consumed quickly, than fed in feeders, where it may spoil.

After emergence, drones can be matured in various types of nursery colonies or in cages. The simplest method is to set the drone producing colony in a location sufficiently isolated from other colonies to prevent undesired drones from drifting in and permitting the drones to emerge in this colony and fly freely.

In situations where some drifting is likely to occur, the drone comb can be caged in an excluder cage permitting the drones to emerge in the drone producing colony or in an incubator, marked as they emerge, and permitted to fly from their original colony or from any convenient colony. The drones can be sprayed with lacquer or enamel from a pressure can using a splatter head in place of the usual spray head. By using different colors a number of kinds of drones can be held in the same colony. Such drones, if caught as they return from the field, will be free of feces and therefore more pleasant to handle than confined drones and less likely to carry disease.

A method we use to mature drones in large numbers is as follows: A drone nursery colony is made up when the drones are nearly ready to emerge. A standard Langstroth two-story hive is used. Excluders are placed just above the bottom board and between the two hive bodies. The colony is made up with two or three combs of worker brood (all stages), two or three combs containing honey and abundant pollen, and 4 to 5 pounds of bees. The combs, including the comb of drone brood, are placed in the lower body. Unwanted drone brood in the worker brood combs is killed at time of installation and 10 days later when young drone brood that was overlooked is old enough to be easily seen. Other combs are added later if needed. The bees are released from a screen cage in the second body and, as they pass through the excluder to the combs below, the unwanted drones among these bees remain above the excluder and are lifted off the next day with the upper hive body and destroyed. An auger hole in the hive body wall above the entrance, 1 inch in diameter,

covered with excluder, permits taking drones into small cages during the afternoons for use in insemination.

The bees rear their own queen which remains virgin because she cannot escape through the queen excluders to leave the hive to mate. Her presence prevents the development of laying workers. When the drones have been utilized, the colony is disposed of or the excluder removed for the virgin to mate and establish a colony.

During the afternoons the drones attempting to leave the hive crowd the forward part of the excluder leaving the rear part for the worker bees to pass through thus preventing clogging of the entrance. All manipulations are made early in the morning while drones are not normally flying. The three most important requirements of the drone nursery colony are ample young bees, ample pollen, and absence of a laying queen.

As described, such a nursery colony will take good care of about 1,500 drones—the number that might emerge from half of a standard Langstroth comb. A larger colony should be established for a larger number. When the desired number of drones has emerged, the drone comb can be removed to restrict the age span, or the drone comb can be moved to a new unit every few days so that all the drones in a given unit will mature at about the same time. For best results, confined drones should be used soon after they mature (between 12 and 20 days old) although they can be used as early as sperm can be obtained.

The above method is especially useful when large numbers of drones are needed. When only a few drones of each of several kinds are needed, it may be more convenient to mature them in cages in a nursery colony like the one described for queen storage. In fact, drones and virgin queens can be kept in the same colony. A drone maturing cage (fig. 13, *B*) has a screen which slides out; the other side is covered with excluder material. The cages are placed in the colony in holding frames with the excluder facing a comb of unsealed brood. The drones can be emerged from drone brood in cages in an incubator and transferred to the storage cages soon after emergence, or newly emerged drones can be collected from the breeder colony.

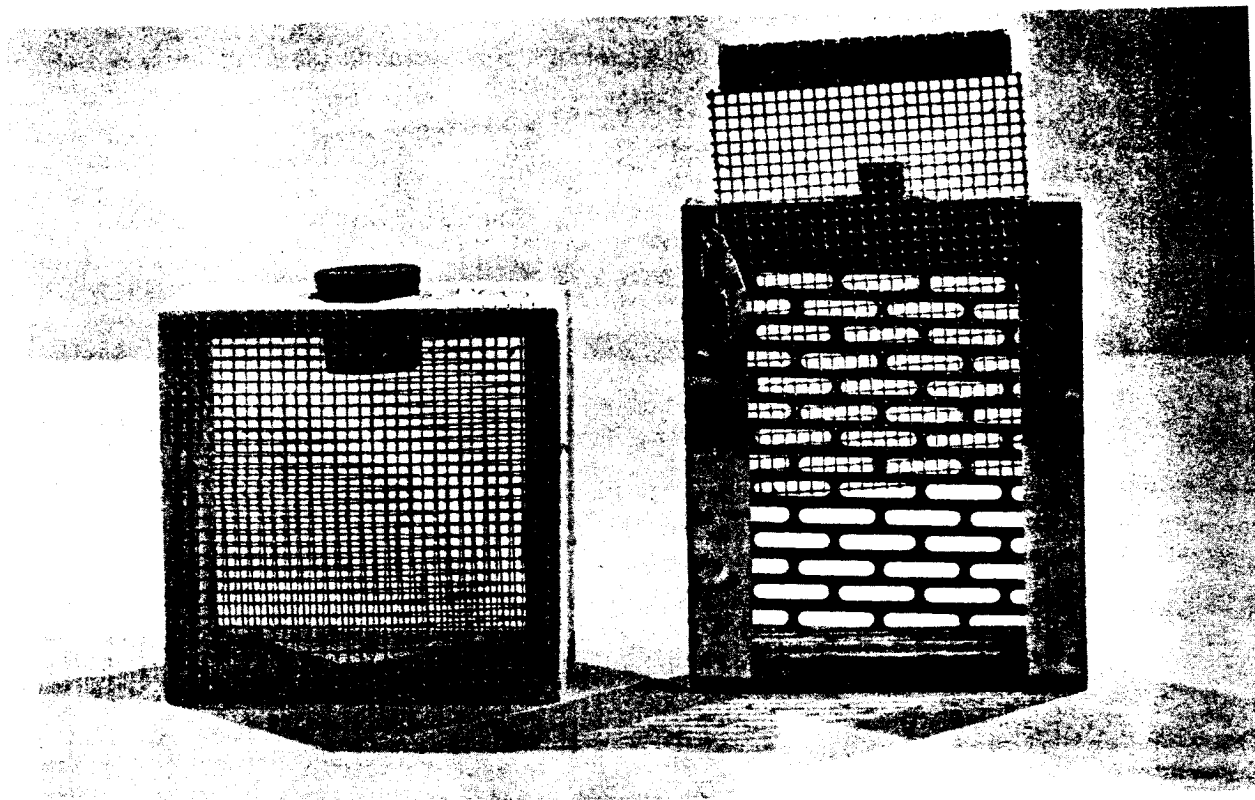

FIGURE 13.—A, Drone collecting cage; and B, drone maturing cage.

COLLECTION OF DRONES FOR INSEMINATION

In collecting drones for insemination, we make use of a screen cage 4 by 4 by 1½ inches (fig. 13, A) with a 1-inch hole that can be closed with a rubber stopper. When this cage is held over the hole in the front of the drone nursery colony, a large number of drones can be collected in a few minutes as they seek exit in the afternoons. If they are not to be used immediately, worker bees are added through a funnel, the cage is laid on its side in the laboratory, and a gravity feeder containing sugar syrup is placed on the screen. These cages of drones can also be temporarily stored between brood combs in a queenless colony or above a queen excluder in a queen-right colony. Drones can be kept this way overnight or for a day or two.

For use in insemination, these cages of drones, with or without worker bees, are placed in a larger screen cage next to the insemination apparatus. The larger cage is 7 by 7 by 12

inches with a door at one end through which the drones can be taken one by one by reaching into the cage. The other end is covered with a queen excluder and opens to the outside of the building. Both drones and worker bees are attracted to the outside light, and the worker bees gradually leave through the excluder.

In bad weather or in the mornings when drones are not attempting to leave the hive, they can be taken from the combs, but young drones must be avoided. The older drones are usually found on the side combs in the lower part of the hive. When drones are confined to a nursery colony but not caged, the older drones can be easily distinguished. The drones gradually rub off the hair on the upper surface of the thorax just behind the head as they try to leave the hive through the excluder material. The older the drones are, the larger this polished area will be.

CONTROL OF PARENTAGE

When rearing daughter queens or drones from a selected breeder colony, one must take all possible precautions to assure that the queens and drones are reared from the breeder's eggs, not from any other source.

In rearing queens, the young worker larvae grafted into the cell cups must be those originating from the breeder queen. Adequate assurance of this is that the breeder queen can be positively identified, that she is present at the time, and that no other laying queen is present. Alternate breeders should be available in case the first choice is lost or superseded.

In rearing drones, care must be taken to avoid the use of drones reared from eggs laid by laying workers of a foreign source which may have drifted in from other colonies or which may have been added to maintain the breeder colony or drone nursery.

The use of drones from laying workers can largely be prevented by the following manage-

ment practices applied to breeder queen colonies and drone nursery colonies:

1. Whenever possible use bees that are daughters of the breeder queen.

2. If unrelated bees are used, avoid taking bees from colonies that have been queenless recently because such bees are more likely to become laying workers.

3. When utilizing drones and queens in insemination, discard any that are not typical of the stock.

4. Use drones from a drone nursery colony within 23 days of the time it was made up, or destroy any drone brood that could be developing from laying workers' eggs. A drone nursery colony may develop some laying workers easily if it should accidentally become queenless.

5. Whenever practical, use bees of a distinguishable color when stocking breeding colonies or drone nursery colonies, so that queen and drone progeny of the worker bees are easily recognizable.

BIBLIOGRAPHY

- (1) BISHOP, G. H.
1920. FERTILIZATION IN THE HONEY BEE. I. THE MALE SEXUAL ORGANS: THEIR HISTOLOGICAL STRUCTURE AND PHYSIOLOGICAL FUNCTIONING. *Jour. Expt. Zool.* 31: 225-265. (The structure and function of the drone's reproductive organs.)
- (2) _____
1920. FERTILIZATION IN THE HONEY BEE. II. DISPOSAL OF THE SEXUAL FLUIDS IN THE ORGANS OF THE FEMALE. *Jour. Expt. Zool.* 31: 267-286. (A study of natural insemination.)
- (3) CAMARGO, J. M. F. DE and GONCALVES, L. S.
1968. NOTE ON TECHNIQUES FOR INSTRUMENTAL INSEMINATION OF QUEEN HONEYBEES. *Jour. Apic. Res.* 7: 157-161. (Staining the vaginal orifice with fast green; a manipulator for the valvelfold probe.)
- (4) FRESNAYE, J.
1966. INFLUENCE DES VARIATIONS DE L'AGE DE MARURITE SEXUALLE CHEZ LES REINES D'ABEILLES (APIS MELLIFERA) FECONDEES PAR INSEMINATION ARTIFICIELLE. *Ann. Abeille* 9: 237-242. (Sexual maturity reached later by queens during cool weather.)
- (5) LAIDLAW, H. H.
1944. ARTIFICIAL INSEMINATION OF THE QUEEN BEE (APIS MELLIFERA L.): MORPHOLOGICAL BASIS AND RESULTS. *Jour. Morph.* 74: 426-465. (The importance to insemination of the reproductive organs of queens and drones; the importance of the queen's valvelfold; new equipment for insemination including the sting hook and valvelfold probe; better insemination than earlier techniques.)
- (6) _____
1949. DEVELOPMENT OF PRECISION INSTRUMENTS FOR ARTIFICIAL INSEMINATION OF QUEEN BEES. *Jour. Econ. Ent.* 42: 254-261. (History of equipment for instrumental insemination; description of Laidlaw apparatus and its use.)
- (7) _____
1953. AN ANESTHETIZATION CHAMBER FOR THE ARTIFICIAL INSEMINATION OF QUEEN BEES. *Jour. Econ. Ent.* 46: 167-168. (Laidlaw queen holder redesigned to include anesthetization chamber.)

- (8) LAIDLAW, H. H.
1951. BEEKEEPING MANAGEMENT FOR THE BEE BREEDER. Amer. Bee Jour. 94: 92-95. (Rearing drones, maturing drones, and queens in nursery colonies.)
- (9) _____
1958. ORGANIZATION AND OPERATION OF A BEE BREEDING PROGRAM Tenth Internat. Cong. Ent. Proc. (1956) 4: 1067-1078. (Scheduling and production of inseminated queens; testing of breeding stock.)
- (10) _____ and ECKERT, J. E.
1962. QUEEN REARING. Univ. Calif. Press, Berkeley and Los Angeles. 165 pp., illus. (Rearing and care of queens; bee breeding; instrumental insemination.)
- (11) MACKENSEN, O.
1947. EFFECT OF CARBON DIOXIDE ON INITIAL OVIPOSITION OF ARTIFICIALLY INSEMINATED AND VIRGIN QUEEN BEES. Jour. Econ. Ent. 40: 344-349. (Carbon dioxide hastens onset of laying in queens not naturally mated.)
- (12) _____
1948. A NEW SYRINGE FOR THE ARTIFICIAL INSEMINATION OF QUEEN BEES. Amer. Bee Jour. 88: 412. (First design of Mackensen syringe.)
- (13) _____
1954. SOME IMPROVEMENTS IN METHODS AND SYRINGE DESIGN IN ARTIFICIAL INSEMINATION OF QUEEN BEES. Jour. Econ. Ent. 47: 765-768. (Directions for the construction of the improved Mackensen syringe, and the management of queens and drones used in insemination.)
- (14) _____
1955. EXPERIMENTS IN THE TECHNIQUE OF ARTIFICIAL INSEMINATION OF QUEEN BEES. Jour. Econ. Ent. 48: 418-421. (The sexual maturity of drones and queens; variations in the treatment of queens and sperm used in instrumental insemination.)
- (15) _____
1964. RELATION OF SEMEN VOLUME TO SUCCESS IN ARTIFICIAL INSEMINATION OF QUEEN HONEY BEES. Jour. Econ. Ent. 57: 581-583. (The number of sperm which get into the spermatheca from semen loads of differing sizes.)
- (16) _____ and ROBERTS, W. C.
1948. A MANUAL FOR THE ARTIFICIAL INSEMINATION OF QUEEN BEES. U.S. Bur. Ent. and Plant Quar. Et-250, 33 pp. (Techniques and equipment for artificial insemination and the care of queens and drones.)
- (17) NOLAN, W. J.
1932. BREEDING THE HONEY BEE UNDER CONTROLLED CONDITIONS. U.S. Dept. Agr. Tech. Bul. 326, 49 pp. (Early techniques and equipment for instrumental insemination.)
- (18) POOLE, H. K. and TABER, STEPHEN, III
1969. A METHOD OF IN VITRO STORAGE OF HONEY-BEE SEMEN. Amer. Bee J. 109: 420-421.
- (19) ROBERTS, W. C.
1946. THE PERFORMANCE OF THE QUEEN BEE. Amer. Bee Jour. 86: 185-186, 211. (Comparison of honey yields between colonies with naturally mated and instrumentally inseminated queens.)
- (20) _____
1947. A SYRINGE FOR ARTIFICIAL INSEMINATION OF HONEY BEES. Jour. Econ. Ent. 40: 445-446. (First syringe with a removable plastic tip.)
- (21) RUTTNER, F.
1956. THE MATING OF THE HONEY BEE. Bee World 37: 2-15, 23-24. (A review of knowledge of natural mating.)
- (22) _____ ed.
1970. THE INSTRUMENTAL INSEMINATION OF THE QUEEN BEE. Apimondia Publishing House, Bucharest, Romania. 78 pp. (A thorough treatment of the subject including anatomy and physiology of reproduction and genetic aspects.)
- (23) SNODGRASS, R. E.
1956. ANATOMY OF THE HONEY BEE. Comstock: Ithaca. 334 pp. (Includes the anatomy of the reproductive systems of queens and drones.)
- (24) TABER, S., III
1961. SUCCESSFUL SHIPMENT OF HONEY BEE SEMEN. Bee World 42: 173-176. (Describes preparation for shipment.)
- (25) WATSON, L. R.
1927. CONTROLLED MATING OF QUEEN BEES. American Bee Journal, Hamilton, Ill., 50 pp. (Early techniques and apparatus for instrumental insemination.)
- (26) WOYKE, J.
1960. (NATURAL AND ARTIFICIAL INSEMINATION OF QUEEN HONEY BEES) Pszczel. Zes. Nauk. 4: 183-275. (In Polish.) (Comparison of natural and instrumental insemination; adequacy of insemination.)
- (27) _____
1964. CAUSES OF REPEATED MATING FLIGHTS BY QUEEN HONEYBEES. Jour. Apic. Res. 3: 17-23. (Poor inseminations lead to further mating flights in natural insemination.)